



Alternators

LSA 49.1 - 4 Pole

Electrical and mechanical data

SPECIALLY ADAPTED FOR APPLICATIONS

The LSA 49.1 alternator is designed to be suitable for typical generator applications, such as: backup, standard production, cogeneration, marine applications, rental, telecommunications, etc.

COMPLIANT WITH INTERNATIONAL STANDARDS

The LSA 49.1 alternator conforms to the main international standards and regulations:

IEC 60034, NEMA MG 1.22, ISO 8528, CSA, CSA/UL, marine regulations, etc.

It can be integrated into a CE marked generator.

The LSA 49.1 is designed, manufactured and marketed in an ISO 9001 environment.

TOP OF THE RANGE ELECTRICAL PERFORMANCE

- Class H insulation.
- Standard 6-wire re-connectable winding, 2/3 pitch, type no. 6.
- Voltage range 50 Hz : 380V - 400V - 415V and 220V - 230V - 240V ,
- Voltage range 60 Hz : 380V - 416V - 440V - 480V and 220 V - 240 V.
- High efficiency and motor starting capacity.
- Other voltages are possible with optional adapted windings :
 - 50 Hz : 440 V (no. 7), 500 V (no. 9), 600 V (no. 22 or 23), 690 V (no. 10 or 52)
 - 60 Hz : 380 V and 416 V (no. 8), 600 V (no. 9).
- Total harmonic content < 4 %.
- R 791 interference suppression conforming to standard EN 55011 group 1 class B standard for European zone (CE marking).

EXCITATION AND REGULATION SYSTEM SUITED TO THE APPLICATION

Voltage regulator	Excitation system		Regulation options				
	AREP	PMG	Current transformer for paralleling	Mains paralleling R 726	3-phase sensing R 731 R 734 mains paralleling unbalanced		Remote voltage potentiometer
R 448	Std	Option	√	√	√	√	√

Voltage regulator accuracy +/- 0.5%.

PROTECTION SYSTEM SUITED TO THE ENVIRONMENT

- The LSA 49.1 is IP 23.
- Standard winding protection for clean environments with relative humidity ≤ 95 %, including indoor marine environments.
- Options:
 - Filters on air inlet and air outlet (IP 44).
 - Winding protections for harsh environments and relative humidity greater than 95%.
 - Space heaters.
 - Thermal protection for winding.

REINFORCED MECHANICAL STRUCTURE USING FINITE ELEMENT MODELLING

- Standard direction of rotation : clockwise when looking at the drive end view (engine side).
- Compact and rigid assembly to better withstand generator vibrations.
- Steel frame.
- Cast iron flanges and shields.
- Twin-bearing and single-bearing versions designed to be suitable for engines on the market.
- Half-key balancing.
- Regreasable bearings.

ACCESSIBLE TERMINAL BOX PROPORTIONED FOR OPTIONAL EQUIPMENT

- Easy access to the voltage regulator and to the connections.
- Possible clusion of accessories for paralleling, protection and measurement.
- Connection bar for reconnecting voltage .

Copyright 2004 : MOTEURS LEROY-SOMER

Products and materials shown in this catalogue may, at any time, be modified in order to follow the latest technological developments, improve the design or change conditions of utilization. Their description cannot, in any case, engage LEROY-SOMER liability. The values indicated are typical values.

Common data

Insulation class	H	Excitation system	A R E P or PMG
Winding pitch	2/3 (N° 6S)	A.V.R. model	R 448
Terminals	6	Voltage regulation (*)	± 0,5 %
Drip proof	IP 23	Sustained short-circuit current	300% (3 IN) : 10s
Altitude	≤ 1000 m	Total harmonic (* *) TGH / THC	at no load < 4 % - on load < 4%
Overspeed	2250 min ⁻¹	Waveform : NEMA = TIF - (* *)	< 50
Air flow	1 m ³ /s (50Hz) / 1,2 (60Hz)	Wave form : C.E.I. = FHT - (* *)	< 2 %

(*) Steady state duty. (**) Total harmonic content line to line, at no load or full rated linear and balanced load.

Ratings 50 Hz - 1500 R.P.M.

kVA / kW - Power factor = 0,8													
Duty / T° C	Continuous duty / 40 °C						Stand-by / 40 °C			Stand-by / 27 °C			
Class / T° K	H / 125° K			F / 105° K			H / 150° K			H / 163° K			
Phase	3 ph.			3 ph.			3 ph.			3 ph.			
Y	380V	400V	415V	380V	400V	415V	380V	400V	415V	380V	400V	415V	
Δ	220V	230V	240V	220V	230V	240V	220V	230V	240V	220V	230V	240V	
49.1 S4	kVA	660	660	660	594	594	594	693	693	693	725	725	725
	kW	528	528	528	475	475	475	554	554	554	580	580	580
49.1 M6	kVA	725	725	725	653	653	653	760	760	760	800	800	800
	kW	580	580	580	522	522	522	608	608	608	640	640	640
49.1 M75	kVA	775	800	775	698	720	698	810	840	810	850	880	850
	kW	620	640	620	558	576	558	648	672	648	680	704	680
49.1 L9	kVA	880	880	880	792	792	792	920	920	920	960	960	960
	kW	704	704	704	634	634	634	736	736	736	768	768	768
49.1 L10	kVA	890	910	890	800	820	800	934	955	934	979	1000	979
	kW	712	728	712	640	656	640	747	764	747	783	800	783

Ratings 60 Hz - 1800 R.P.M.

kVA / kW - PF = 0,8																	
Duty / T° C	Continuous duty / 40 °C						Stand-by / 40 °C				Stand-by / 27 °C						
Class / T° K	H / 125° K			F / 105° K			H / 150° K				H / 163° K						
Phase	3 ph.			3 ph.			3 ph.				3 ph.						
Y	380V	416V	440V	480V	380V	416V	440V	480V	380V	416V	440V	480V	380V	416V	440V	480V	
Δ	220V	240V			220V	240V			220V	240V			220V	240V			
49.1 S4	kVA	710	710	725	792	639	639	652	712	745	745	760	830	781	781	798	871
	kW	568	568	580	634	511	511	522	570	596	596	608	664	625	625	638	697
49.1 M6	kVA	780	780	800	870	702	702	720	783	819	819	840	913	858	858	880	957
	kW	624	624	640	696	562	562	576	626	655	655	672	730	686	686	704	766
49.1 M75	kVA	866	936	960	960	780	842	865	865	910	983	1008	1008	953	1030	1056	1056
	kW	693	749	768	768	624	674	692	692	728	786	806	806	762	824	845	845
49.1 L9	kVA	910	980	1010	1056	819	882	909	950	955	1029	1060	1108	1000	1078	1111	1162
	kW	728	784	808	845	655	706	727	760	764	823	848	886	800	862	889	930
49.1 L10	kVA	958	1020	1050	1092	862	918	945	983	1006	1071	1102	1146	1054	1122	1155	1200
	kW	766	816	840	874	690	734	756	786	805	857	882	917	843	898	924	960

Efficiencies 50 Hz - P.F. : 1 / P.F. : 0,8

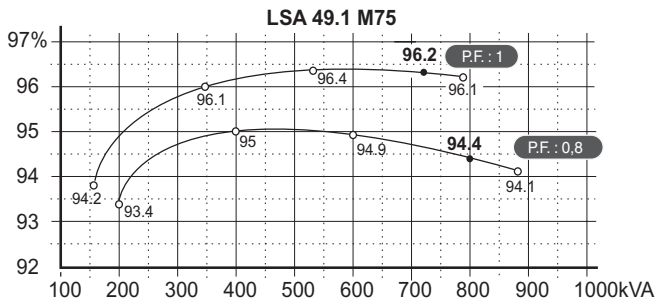
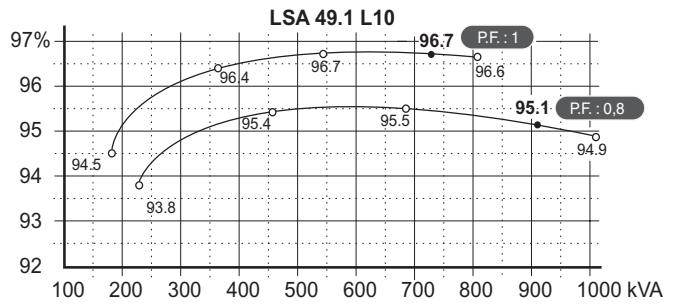
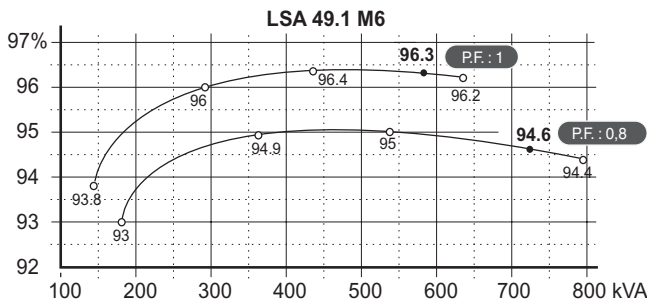
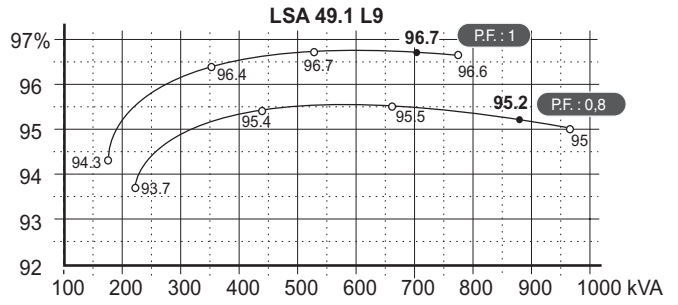
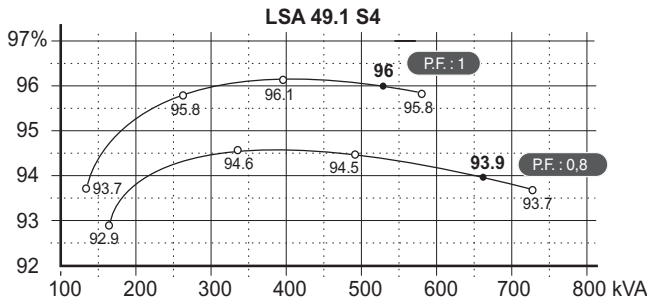

Reactances Class H / 400 V - Time constants (ms)

	S4	M6	M75	L9	L10
Kcc Short-circuit ratio	0,38	0,43	0,39	0,43	0,41
Xd Direct axis synchro.reactance unsaturated	343	301	332	304	315
Xq Quadra. axis synchr.reactance unsaturated	205	180	199	182	189
T'do Open circuit time constant	1958	2047	2047	2111	2111
X'd Direct axis transient reactance saturated	17,5	14,7	16,2	14,4	14,9
T'd Short-Circuit transient time constant	100	100	100	100	100
X''d Direct axis subtransient reactance saturated	14	11,7	12,9	11,5	11,9
T''d Subtransient time constant	10	10	10	10	10
X''q Quadra. axis subtransient reactance saturated	16,3	13,1	14,5	12,5	13
Xo Zero sequence reactance unsaturated	0,9	0,7	0,8	0,8	0,9
X2 Negative sequence reactance saturated	15,2	12,5	13,8	12,1	12,5
Ta Armature time constant	15	15	15	15	15

Other data - Class H / 400 V

	S4	M6	M75	L9	L10
io (A) No load excitation current	0,9	0,9	0,9	0,9	0,9
ic (A) Full load excitation current	3,6	3,2	3,5	3,3	3,4
uc (V) Full load excitation voltage	43	38	41	39	40
ms Recovery time ($\Delta U = 20\%$ trans.)	500	500	500	500	500
kVA Motor start. ($\Delta U = 20\%$ sust.) or ($\Delta U = 50\%$ trans.)	1578	1985	1985	2372	2372
% Transient dip (rated step load) - PF : 0,8 LAG	13,3	10,9	11,7	10,7	11
W No load losses	8110	9000	9000	9860	9860
W Heat rejection	33710	32740	37700	35340	37030

Transient voltage variation 400V - 50 Hz

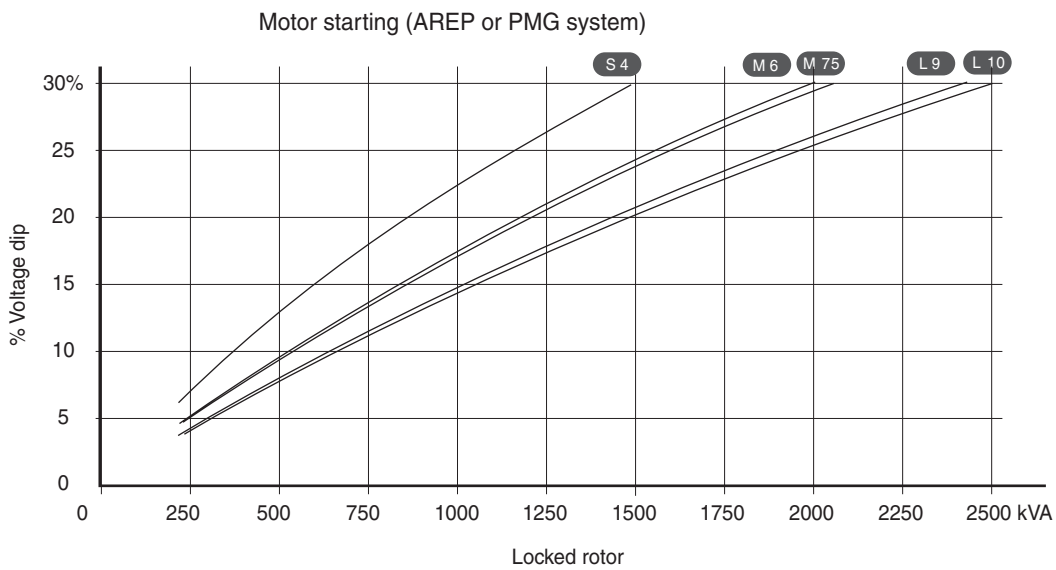
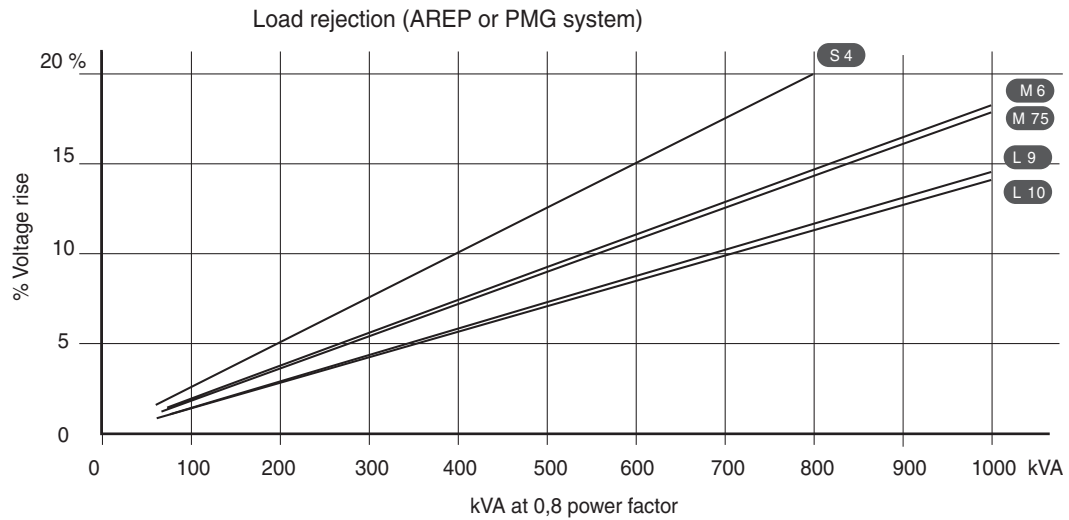
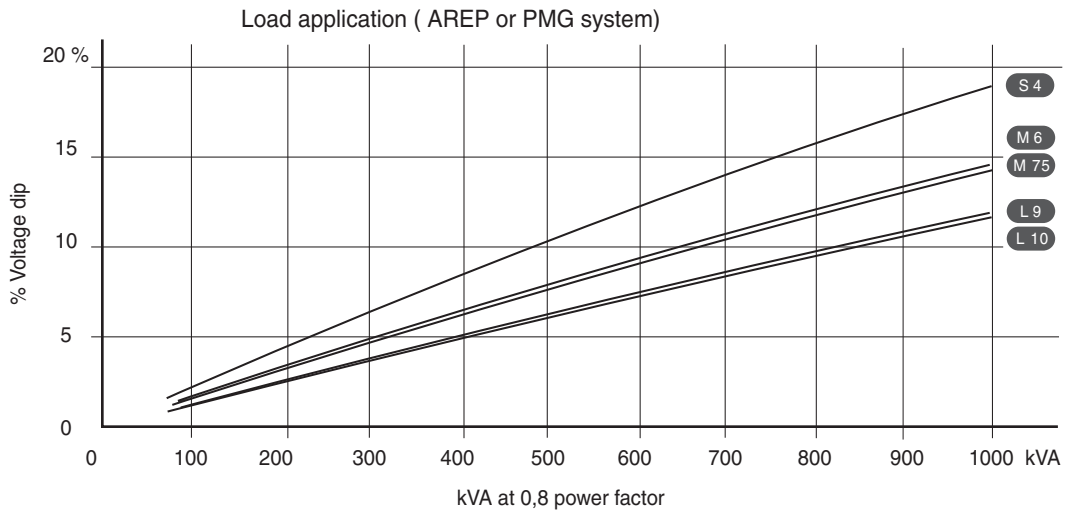

1) For a starting P.F. differing from 0,6, the starting kVA must be multiplied by (Sine Ø / 0,8)

2) For voltages other than 400 V (Y) , 230 V (Δ) at 50 Hz , then kVA must be multiplied by $(400/U)^2$ ou $(230/U)^2$.

Efficiencies 60 Hz - P.F. : 1 / P.F. : 0,8

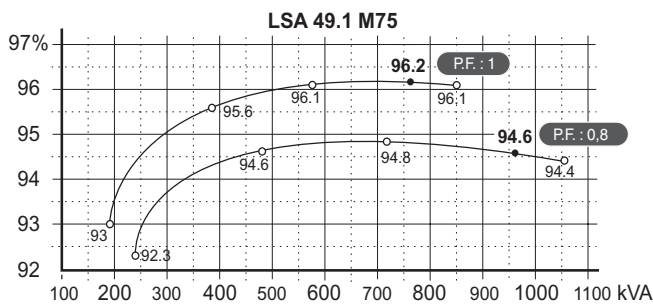
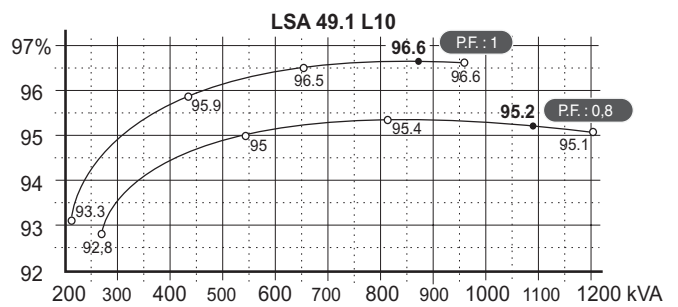
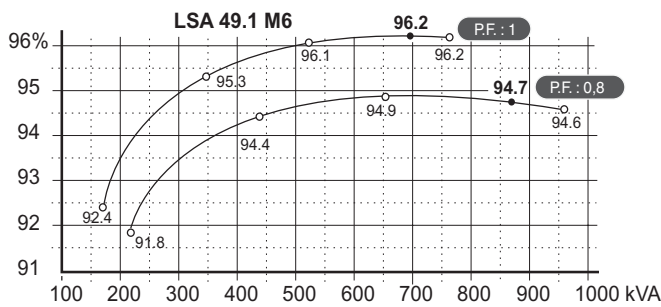
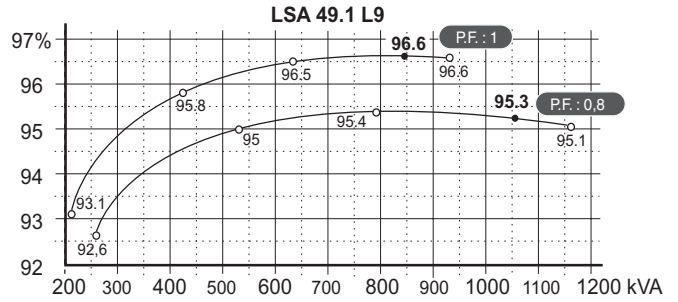
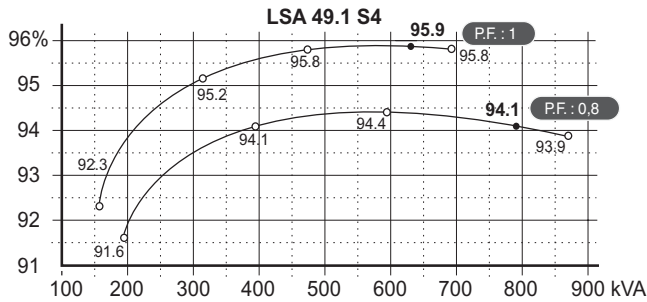

Reactances Class H / 480 V - Time constants (ms)

	S4	M6	M75	L9	L10
Kcc Short-circuit ratio	0,38	0,43	0,39	0,43	0,41
Xd Direct axis synchro.reactance unsaturated	343	301	332	304	315
Xq Quadra. axis synchr.reactance unsaturated	205	180	199	182	189
T'do Open circuit time constant	1958	2047	2047	2111	2111
X'd Direct axis transient reactance saturated	17,5	14,7	16,2	14,4	14,9
T'd Short circuit transient time constant	100	100	100	100	100
X''d Direct axis subtransient reactance saturated	14	11,7	12,9	11,5	11,9
T''d Subtransient time constant	10	10	10	10	10
X''q Quadra. axis subtransient reactance saturated	16,3	13,1	14,5	12,5	13
Xo Zero sequence reactance unsaturated	0,9	0,7	0,8	0,8	0,9
X2 Negative sequence reactance saturated	15,2	12,5	13,8	12,1	12,5
Ta Armature time constant	15	15	15	15	15

Other data - Class H / 480 V

	S4	M6	M75	L9	L10
io (A) No load excitation current	0,9	0,9	0,9	0,9	0,9
ic (A) Full load excitation current	3,6	3,2	3,5	3,2	3,3
uc (V) Full load excitation voltage	42	38	41	38	39
ms Recovery time ($\Delta U = 20\%$ trans.)	500	500	500	500	500
kVA Motor start. ($\Delta U = 20\%$ sust.) or ($\Delta U = 50\%$ trans.)	1950	2482	2482	2972	2972
% Transient dip (rated step load) - PF : 0,8 LAG	13,3	10,9	11,7	10,7	11
W No load losses	12570	13820	13820	15030	15030
W Heat rejection	39100	38520	43730	41600	43380

Transient voltage variation 480V - 60 Hz

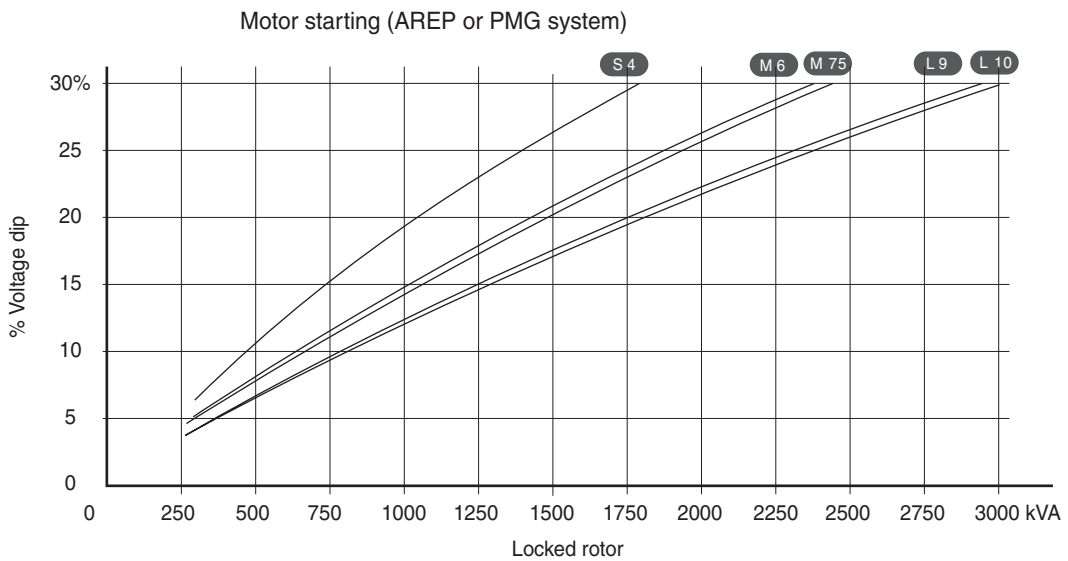
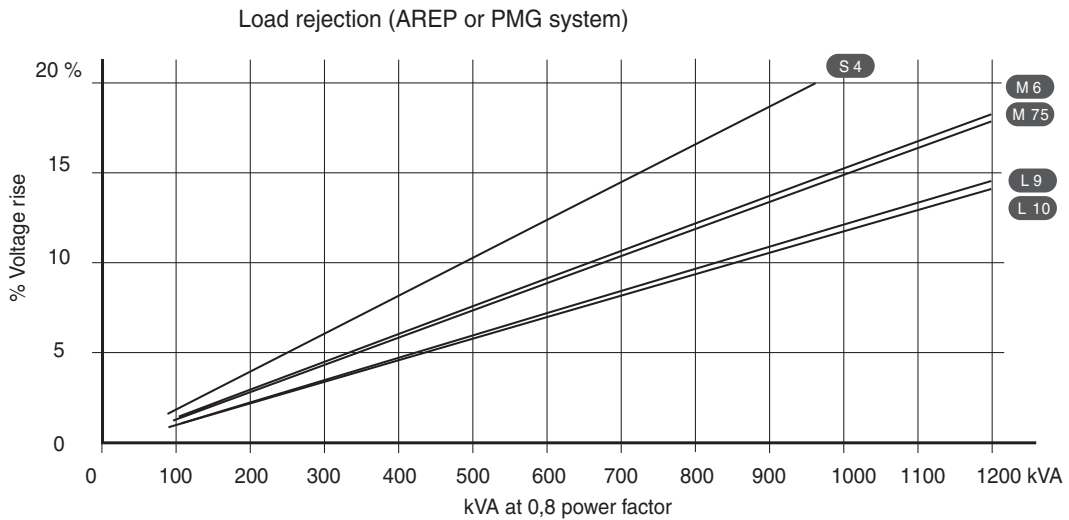
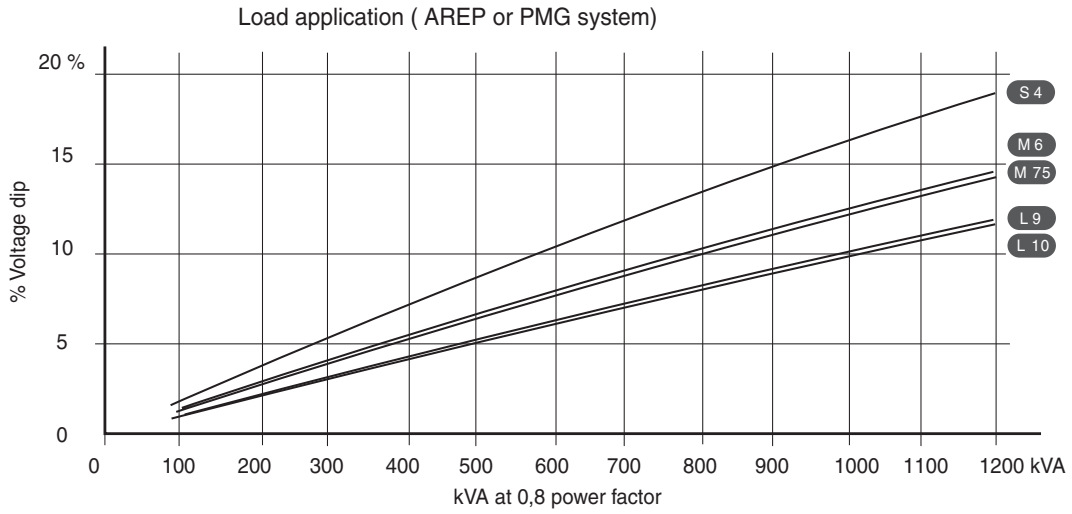

- 1) For a starting P.F. differing from 0,6 , the starting kVA must be multiplied by $(\text{Sine } \varnothing / 0,8)$.
- 2) For voltages other than 480 V (Y) , 277 V (Δ) , 240 V (YY) at 60 Hz , then, kVA must be multiplied by $(480 / U)^2$ or $(277 / U)^2$ or $(240/U)^2$.

3 phase short-circuit curves at no load and rated speed (star connection Y)

LSA 49.1 S4

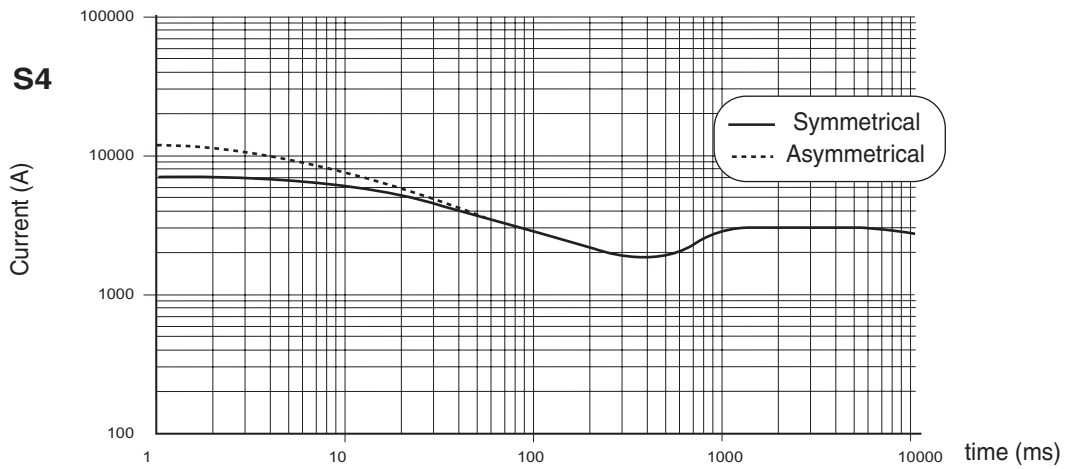

LSA 49.1 M6

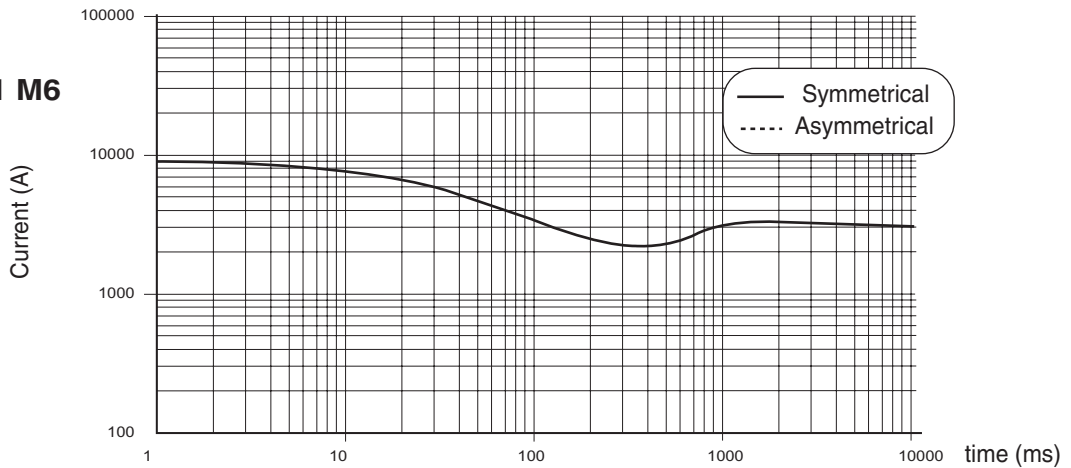

LSA 49.1 M75

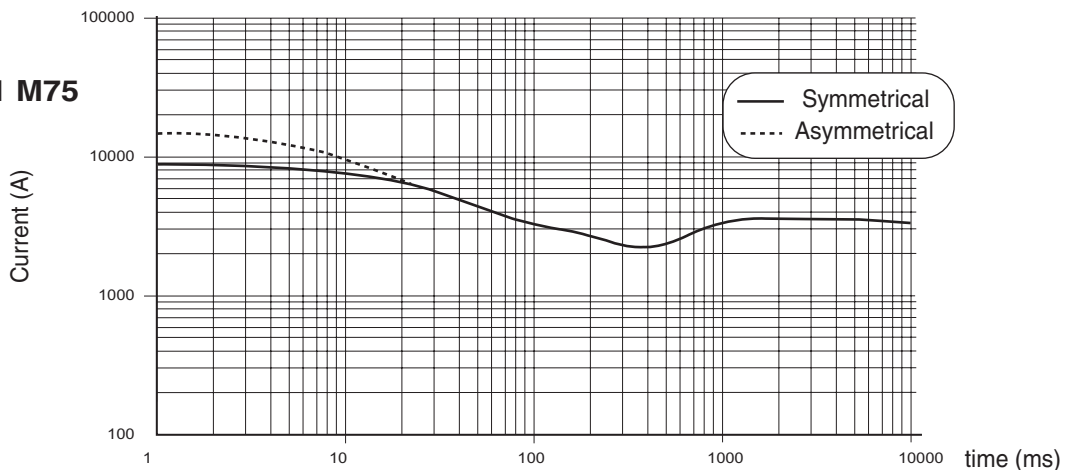

Influence due to connexion

Curves shown are for star connection (Y).

For other connections, use the following multiplication factors :

- Series delta : Current value x 1,732
- Parallel star : Current value x 2

3 phase short-circuit curves at no load and rated speed (star connection Y)

LSA 49.1 L9

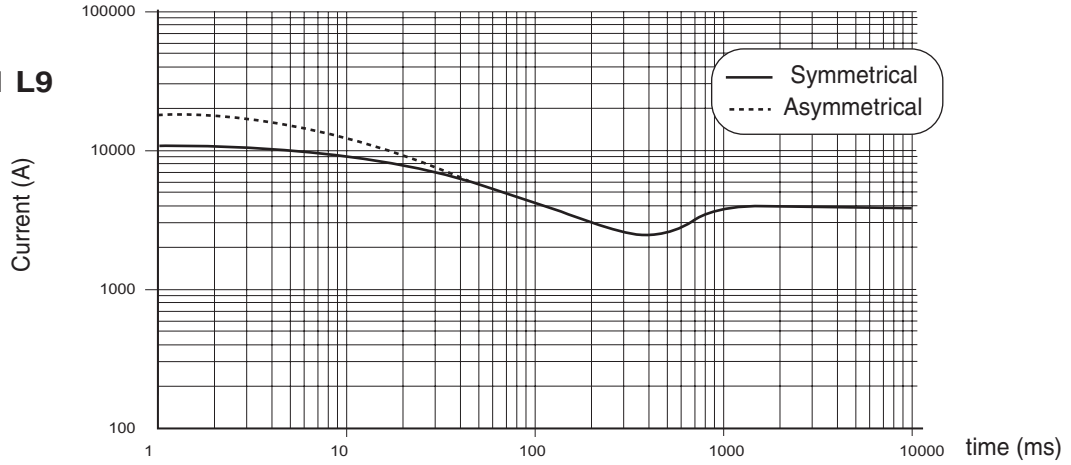

LSA 49.1 L10

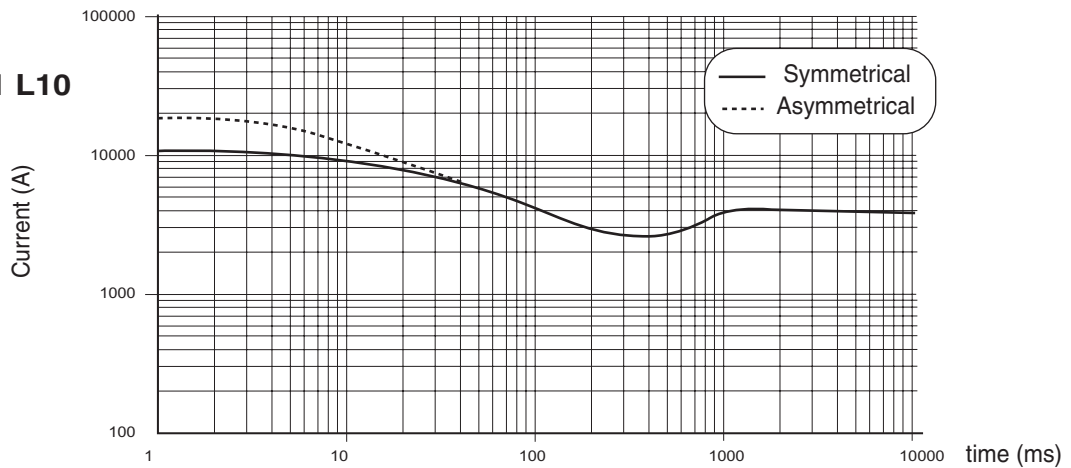

Influence due to short-circuit.

Curves are based on a three-phase short-circuit.

For other types of short-circuit, use the following multiplication factors :

	3 phase	2 phase L - L.	1 phase L - N.
Instantaneous (Max)	1	0,87	1,3
Sustained	1	1,5	2,2
Max sustained duration (AREP/ PMG)	10 sec.	5 sec.	2 sec.

Single bearing dimensions

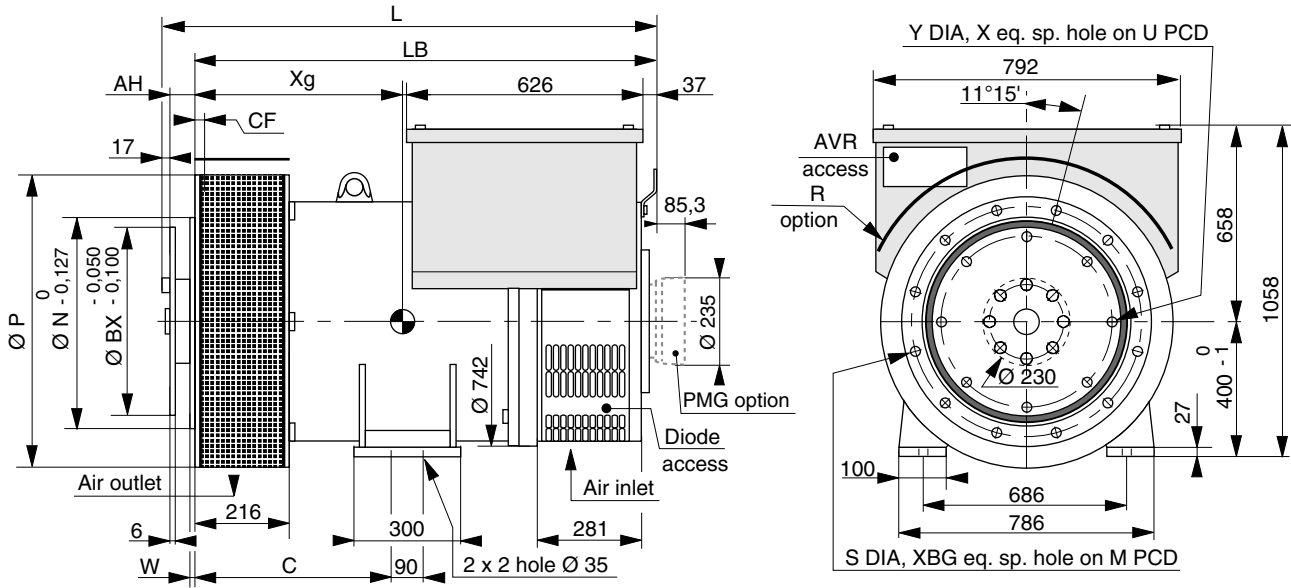

Frame dimensions (mm)						Coupling		
TYPE	L max without PMG	LB	C	Xg	Weight (kg)	Flex plate	14	18
LSA 49.1 S4	1315	1272	560	635	1445			
LSA 49.1 M6	1415	1372	650	670	1645	Flange S.A.E	X	X
LSA 49.1 M75	1415	1372	650	670	1645	Flange S.A.E		X
LSA 49.1 L9	1515	1472	650	710	1845			
LSA 49.1 L10	1515	1472	650	710	1845			

Flange dimensions (mm)									Flex plate dimensions (mm)					
S.A.E.	P	N	M	XBG	S	W	R	CF	S.A.E.	BX	U	X	Y	AH
0	752	647,7	679,45	16	14	7	438	17	14	466,7	438,15	8	14	25,4
00	884	787,4	850,9	16	14	6	504	20	18	571,5	542,92	6	17	15,7

Torsional analysis data

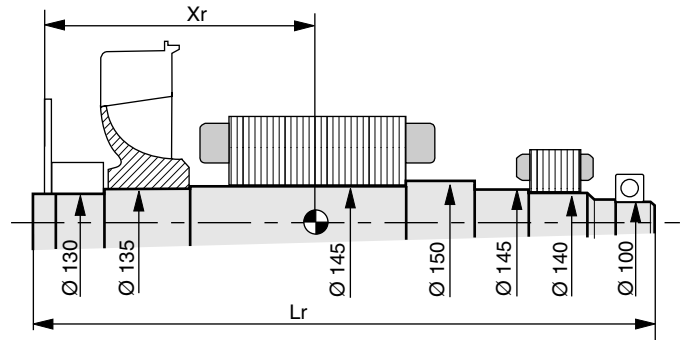

Gravity center : Xr (mm), Rotor length Lr (mm), Weight : M (kg), Moment of inertia : J (kgm ²) : (4J = MD ²)								
TYPE	Xr	Flex plate S.A.E. 14			Flex plate S.A.E. 18			
		Lr	M	J (kg)	Xr	Lr	M	J (kg)
LSA 49.1 S4	601	1280	536	8,51	591	1280	539	8,76
LSA 49.1 M6	651	1380	618	10,14	641	1380	621	10,39
LSA 49.1 M75	651	1380	618	10,14	641	1380	621	10,39
LSA 49.1 L9	701	1480	700	11,78	691	1480	703	12,03
LSA 49.1 L10	701	1480	700	11,78	691	1480	70,3	12,03

Two bearing dimensions

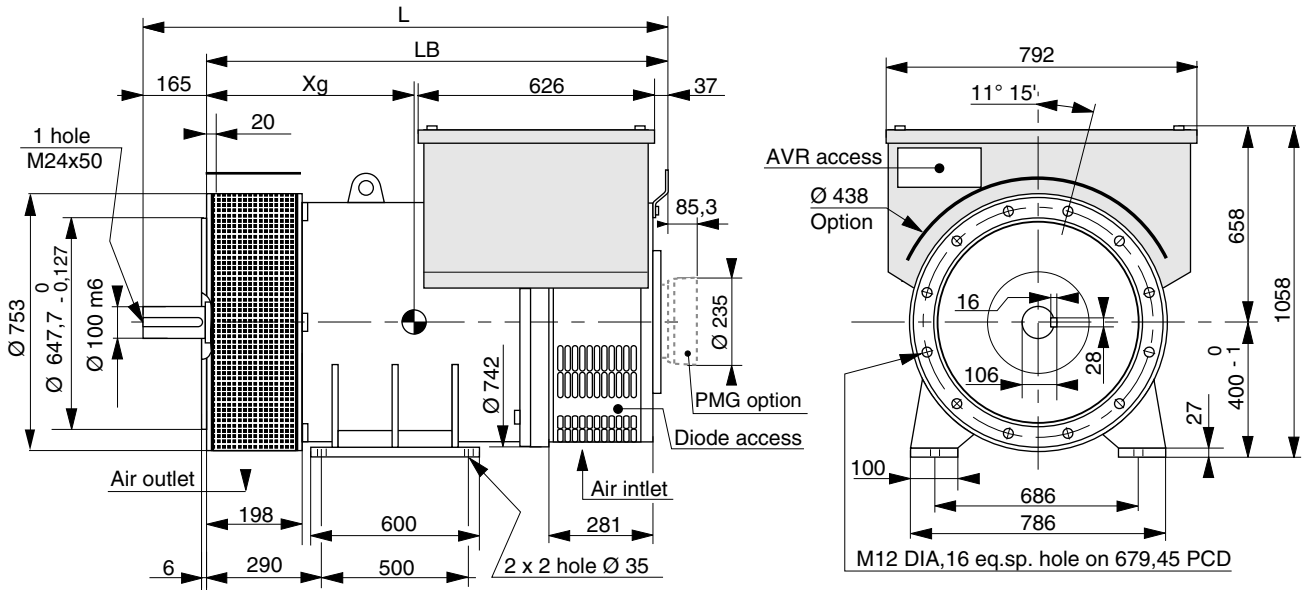

Frame dimensions (mm)

TYPE	L maxi without PMG	LB	Xg	Weight (kg)
LSA 49.1 S4	1419	1254	620	1470
LSA 49.1 M6	1519	1354	655	1670
LSA 49.1 M75	1519	1354	655	1670
LSA 49.1 L9	1619	1454	695	1870
LSA 49.1 L10	1619	1454	695	1870

Torsional analysis data

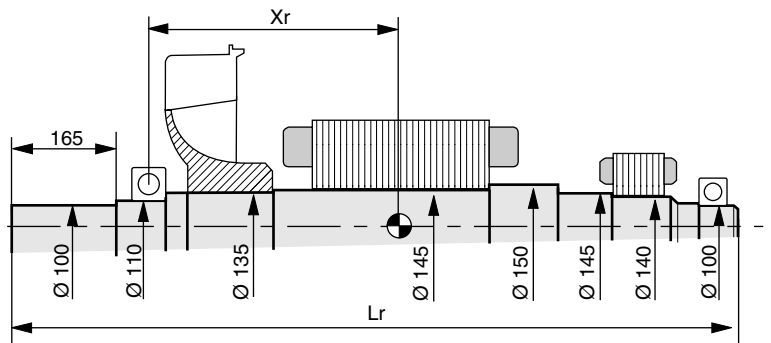

Gravity center : Xr (mm), Rotor length Lr (mm), Weight : M (kg), Moment of inertia : J (kgm²) : (4J = MD²)

TYPE	Xr	Lr	M	J (kg)
LSA 49.1 S4	503	1397	502	8,04
LSA 49.1 M6	553	1497	584	9,67
LSA 49.1 M75	553	1497	584	9,67
LSA 49.1 L9	603	1597	666	11,31
LSA 49.1 L10	603	1597	666	11,31



LEROY-SOMER 16015 ANGOULÊME CEDEX - FRANCE

RCS ANGOULÊME N° B 671 820 223
S.A. au capital de 62 779 000 €

www.leroy-somer.com