

# F160AXP

english

italiano

français

deutsch

español

nederlands

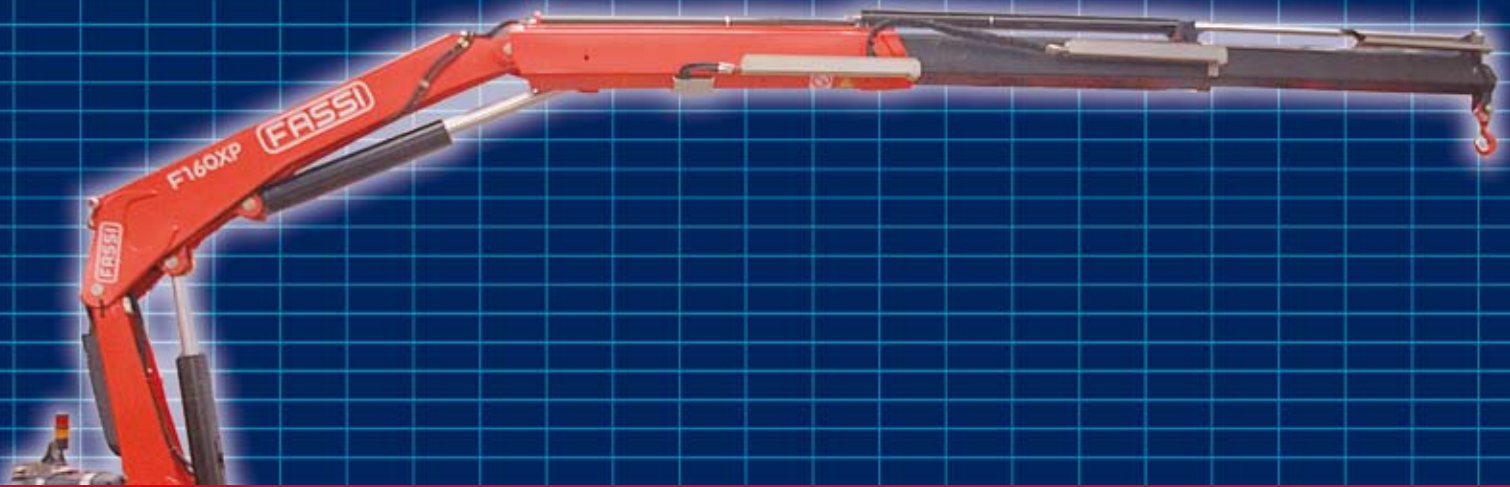

cranes without compromise

**FASSI**

CRANES WITHOUT COMPROMISE

## F160AXP.21

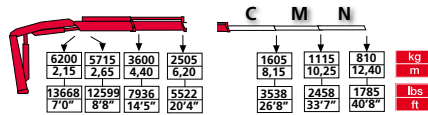

## F160AXP.22

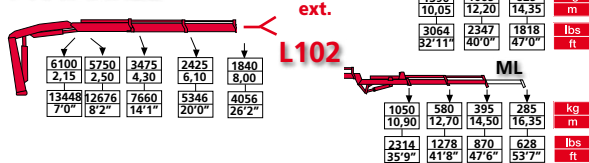

## F160ACXP.22

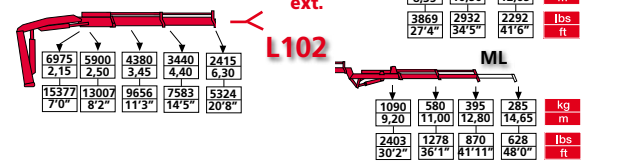

## F160AXP.23

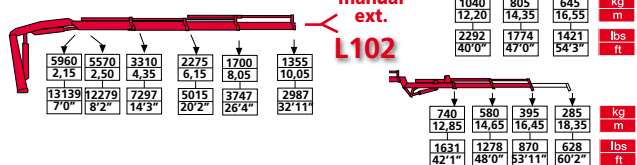

## F160ACXP.23

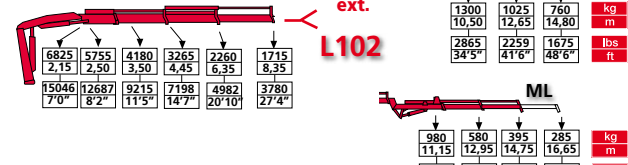

## F160AXP.24

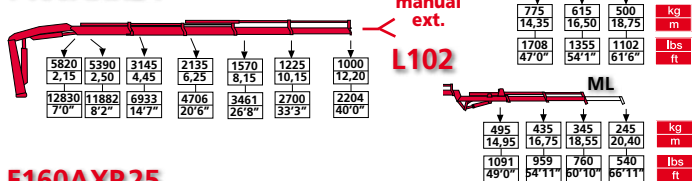

## F160ACXP.24

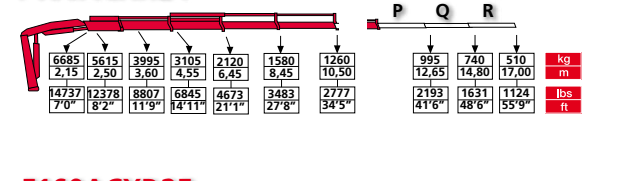

## F160AXP.25

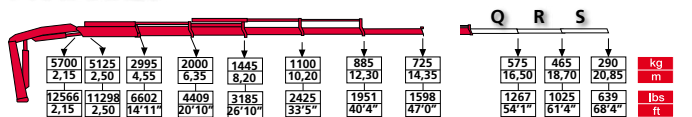

## F160ACXP.25

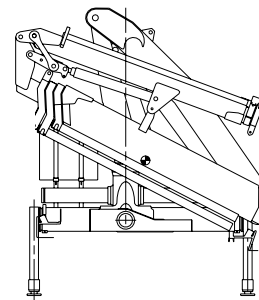
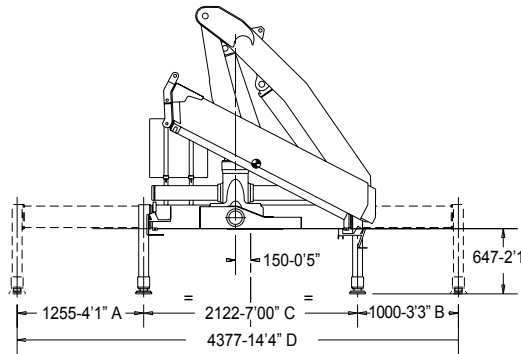
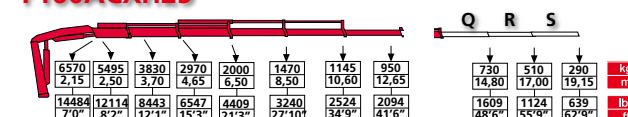

	EXTRA	SUPER-EXTRA
<b>A</b>	1809	1950
	5'11"	6'5"
<b>B</b>	1809	1950
	5'11"	6'5"
<b>C</b>	2310	2300
	7'7"	7'6"
<b>D</b>	5842	6200
	19'2"	20'4"

\* With supplementary hoses  
Con tubazioni supplementari  
Avec tuyauterie supplémentaire  
Con tuberías suplementarias  
Mit zusätzlichen leitungen  
Met extra functies

- GB**
- 1) FX500 electronic control system
  - 2) RCH/RCS remote control
  - 3) MPES system
  - 4) XP System
- IT**
- 1) Sistema di controllo elettronico FX500
  - 2) Radiocomando RCH/RCS
  - 3) Sistema MPES
  - 4) Sistema XP
- FR**
- 1) Système électronique de contrôle FX500
  - 2) Radiocommande RCH/RCS Evolution
  - 3) MPES système
  - 4) XP Système
- ES**
- 1) Sistema electrónico de control FX500
  - 2) Radiomando RCH/RCS
  - 3) Sistema MPES
  - 4) Sistema XP
- DE**
- 1) FX500-System, die elektronische Lastmomentbegr.
  - 2) RCH/RCS-Funkfern-steuerung
  - 3) Multi-Power Ausschubsystem
  - 4) System XP
- NL**
- 1) FX500 electronisch beveiligingssysteem
  - 2) RCH/RCS Evolutie radiografische afstandsbediening
  - 3) MPES-systeem
  - 4) XP-systeem

	tm	lbs.ft	m	ft	m	ft	°	kNm	lbs.ft	Mpa	psi	l/min	gal/min	l	gal	kg	lbs	mm	ft	mm	ft	mm	ft
F160AXP.21	15,8	114281	6,35	20'9"	1,80	5'10"	390	21,5	15862	31,0	4496	40	11	90	24	1680	3705	2380	7'10"	824	2'9"	2205	7'3"
F160AXP.22	14,9	107772	8,30	27'3"	3,70	12'1"	390	21,5	15862	31,0	4496	40	11	90	24	1820	4012	2380	7'10"	827	2'9"	2205	7'3"
F160AXP.23	14,4	104155	10,40	34'1"	5,70	18'8"	390	21,5	15862	31,0	4496	40	11	90	24	1960	4320	2380	7'10"	827	2'9"	2205	7'3"
F160AXP.24	14,0	101262	12,55	41'2"	7,80	25'7"	390	21,5	15862	31,0	4496	40	11	90	24	2080	4585	2420	7'11"	827	2'9"	2205	7'3"
F160AXP.25	13,6	98369	14,70	48'2"	9,85	32'4"	390	21,5	15862	31,0	4496	40	11	90	24	2175	4795	2450	8'0"	963	3'2"	2205	7'3"
F160ACXP.22	15,2	109942	6,60	21'8"	2,85	9'4"	390	21,5	15862	31,0	4496	40	11	90	24	1765	3890	2390	7'10"	827	2'9"	2205	7'3"
F160ACXP.23	14,6	105602	8,65	28'5"	4,80	15'8"	390	21,5	15862	31,0	4496	40	11	90	24	1905	4200	2390	7'10"	827	2'9"	2205	7'3"
F160ACXP.24	14,4	104155	10,80	35'6"	6,90	22'7"	390	21,5	15862	31,0	4496	40	11	90	24	2030	4475	2465	8'1"	827	2'9"	2205	7'3"
F160ACXP.25	14,1	101985	13,00	42'7"	8,95	29'4"	390	21,5	15862	31,0	4496	40	11	90	24	2120	4675	2490	8'2"	963	3'2"	2205	7'3"
F160AXP.22/L102	14,9	107772	14,85	48'9"	7,30	23'11"	390	21,5	15862	31,0	4496	40	11	90	24	2140	4717	2477	8'2"	960	3'2"	2205	7'3"
F160AXP.23/L102	14,4	104155	16,85	55'3"	9,25	30'4"	390	21,5	15862	31,0	4496	40	11	90	24	2280	5025	2477	8'2"	960	3'2"	2205	7'3"
F160AXP.24/L102	14,0	101262	18,90	62'1"	11,35	37'2"	390	21,5	15862	31,0	4496	40	11	90	24	2400	5290	2477	8'2"	960	3'2"	2205	7'3"
F160ACXP.22/L102	15,2	109942	13,35	43'9"	6,60	21'7"	390	21,5	15862	31,0	4496	40	11	90	24	2090	4607	2477	8'2"	960	3'2"	2205	7'3"
F160ACXP.23/L102	14,6	105602	15,15	49'8"	8,40	27'6"	390	21,5	15862	31,0	4496	40	11	90	24	2225	4905	2477	8'2"	960	3'2"	2205	7'3"

Data and descriptions are approximate and not binding - Dati e dimensioni sono forniti a titolo indicativo e non impegnativo - Toutes les données et descriptions sont fournies à titre indicatif, sans engagement Unverbindliche Angaben, Konstruktionsänderungen vorbehalten - Datos y descripciones todos a título indicativo y no imperativo - Specificaties zijn niet bindend, wijzigingen derhalve voorbehouden

