



Alternators
LSA 47.2 - 4 Pole
Electrical and mechanical data

SPECIALLY ADAPTED FOR APPLICATIONS

The LSA 47.2 alternator is designed to be suitable for typical generator applications, such as: stand-by, prime power, cogeneration, marine, rental, telecommunications, etc.

COMPLIANT WITH INTERNATIONAL STANDARDS

The LSA 47.2 alternator conforms to the main international standards and regulations:

IEC 60034, NEMA MG 1.22, ISO 8528, CSA, CSA/UL, marine regulations, etc.

It can be integrated into a CE marked generator-set.

The LSA 47.2 is designed, manufactured and marketed in an ISO 9001 environment.

TOP OF THE RANGE ELECTRICAL PERFORMANCE

- Class H insulation.
- Standard 12-wire re-connectable winding, 2/3 pitch, type no. 6 (the LSA 47.2 L9 is available in two versions: 6-wire and 12-wire).
- Voltage range: 220 V - 240 V and 380 V - 415 V (440 V) - 50 Hz / 208 V - 240 V and 380 V - 480 V - 60 Hz.
- High efficiency and motor starting capacity.
- Other voltages are possible with optional adapted windings:
 - 50 Hz: 440 V (no. 7), 500 V (no. 9), 600 V (no. 22 or 23), 690 V (no. 10 or 52)
 - 60 Hz: 380 V and 416 V (no. 8), 600 V (no. 9).
- Total harmonic content < 2%.
- R 791 interference suppression conforming to standard EN 55011 group 1 class B standard for European zone (CE marking).

EXCITATION AND REGULATION SYSTEM SUITED TO THE APPLICATION

Voltage regulator	Excitation system			Regulation options				
	SHUNT 12 wire only	AREP	PMG	Current transformer for paralleling	Mains paralleling R 726	3-phase sensing R 731 R 734 mains paralleling		Remote voltage potentiometer
R 230	Std	-	-	-	-	-	-	√
R 448	optional	Std	Std	√	√	√	√	√

Voltage regulator accuracy +/- 0.5%.

PROTECTION SYSTEM SUITED TO THE ENVIRONMENT

- The LSA 47. 2 is IP 23.
- Standard winding protection for clean environments with relative humidity ≤ 95 %, including indoor marine environments.
- Options:
 - Filters on air inlet and air outlet (IP 44).
 - Winding protections for harsh environments and relative humidity greater than 95%.
 - Space heaters.
 - Thermal protection for winding.

REINFORCED MECHANICAL STRUCTURE USING FINITE ELEMENT MODELLING

- Standard direction of rotation : clockwise when looking at the drive end view (engine side).
Running unit anti-clockwise: a derate of 5% must be applied.
- Compact and rigid assembly to better withstand generator-set vibrations.
- Steel frame.
- Cast iron flanges and shields.
- Two bearing and single bearing versions designed to be suitable for engines on the market.
- Half-key balancing.
- Greased for life bearings (regreasable bearings optional)

ACCESSIBLE TERMINAL BOX PROPORTIONED FOR OPTIONAL EQUIPMENT

- Easy access to the voltage regulator and to the connections.
- Possible clusion of accessories for paralleling, protection and measurement.
- 8-way terminal block for voltage reconnection.

Common data

Insulation class	H	Excitation system	SHUNT (12 wire)	A R E P or PMG
Winding pitch	2/3 (N° 6 or N° 6S)	A.V.R. model	R 230	R 448
Terminals	12 (N° 6) / 6 (N° 6S)	Voltage regulation (*)	± 0,5 %	± 0,5 %
Drip proof	IP 23	Sustained short-circuit current	-	300% (3 IN) : 10s
Altitude	≤ 1000 m	Total harmonic TGH / THC (**)	at no load < 1,5 % - on load < 2 %	
Overspeed	2250 min ⁻¹	Waveform : NEMA = TIF (**)	< 50	
Air flow	0,9 m ³ /s (50Hz) / 1,1 (60Hz)	Wave form : I.E.C. = THF(**)	< 2 %	

(*) Steady state duty. (**) Total harmonic content line to line, at no load or full rated linear and balanced load.

Ratings 50 Hz - 1500 min.-1

kVA / kW - Power factor = 0,8															
Duty	Continuous duty 40°C				Continuous duty / 40°C				Stand-by/ 40°C			Stand-by / 27°C			
Class/T°K	H / 125° K				F / 105° K				H / 150° K			H / 163° K			
Phase	3 ph.				3 ph.				3 ph.			3 ph.			
Y	380V	400V	415V		380V	400V	415V		380V	400V	415V		380V	400V	415V
Δ	220V	230V	240V		220V	230V	240V		220V	230V	240V		220V	230V	240V
YY		200V				200V				200V				200V	
47.2 VS2	kVA	365				330				405			420		
	kW	292				264				324			336		
47.2 S4	kVA	410				370				430			450		
	kW	328				296				344			360		
47.2 S5	kVA	455				405				471			500		
	kW	364				324				377			400		
47.2 M7	kVA	500				465				545			570		
	kW	400				372				436			456		
47.2 M8	kVA	550				500				575			600		
	kW	440				400				460			480		
47.2 L9	kVA	600				535				630			660		
	kW	480				428				504			528		
Y	380V	400V	415V		380V	400V	415V		380V	400V	415V		380V	400V	415V
	Δ	220V	230V	240V		220V	230V	240V		220V	230V	240V		220V	230V
47.2 L9*	kVA	600				535				630			660		
	kW	480				428				504			528		

Ratings 60 Hz - 1800 min.-1

kVA / kW - PF = 0,8																	
Duty	Continuous duty 40°C				Continuous duty / 40°C				Stand-by / 40 °C			Stand-by / 27 °C					
Class / T° K	H / 125° K				F / 105° K				H / 150° K			H / 163° K					
Phase	3 ph.				3 ph.				3 ph.			3 ph.					
Y	380V	416V	440V	480V	380V	416V	440V	480V	380V	416V	440V	480V	380V	416V	440V	480V	
Δ	220V	240V			220V	240V			220V	240V			220V	240V			
YY		208V	220V	240V		208V	220V	240V		208V	220V	240V		208V	220V	240V	
47.2 VS2	kVA	424	454	456	456	394	410	410	410	451	483	500	511	469	500	518	530
	kW	339	363	365	365	315	328	328	328	361	386	400	409	375	400	414	424
47.2 S4	kVA	450	480	500	512	396	442	442	465	475	513	533	550	500	530	550	581
	kW	360	384	400	410	317	354	354	372	380	410	426	440	400	424	440	465
47.2 S5	kVA	475	510	531	570	441	473	493	518	503	543	566	592	527	562	585	625
	kW	380	408	425	456	353	378	394	414	402	434	453	474	422	450	468	500
47.2 M7	kVA	562	610	625	625	523	566	581	590	600	651	669	680	625	668	690	700
	kW	450	488	500	500	418	453	465	472	480	521	535	554	500	534	552	560
47.2 M8	kVA	562	610	630	690	523	566	587	632	600	651	672	729	625	671	705	750
	kW	450	488	504	552	418	453	470	506	480	521	538	583	500	537	564	600
47.2 L9	kVA	602	661	685	750	556	609	634	675	643	707	734	780	667	728	763	825
	kW	482	529	548	600	445	487	507	540	514	566	587	624	534	582	610	660
Y	380V	416V	440V	480V	380V	416V	440V	480V	380V	416V	440V	480V	380V	416V	440V	480V	
	Δ	220V	240V			220V	240V			220V	240V			220V	240V		
47.2 L9*	kVA	602	661	685	750	556	609	634	675	643	707	734	780	667	728	763	825
	kW	482	529	548	600	445	487	507	540	514	566	587	624	534	582	610	660

* AREP excitation only

Efficiencies 50 Hz - P.F. : 1 / P.F. : 0,8

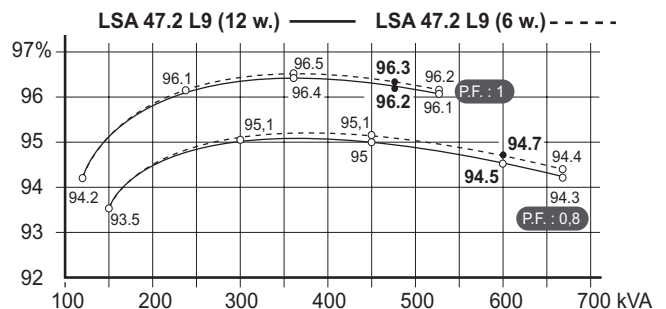
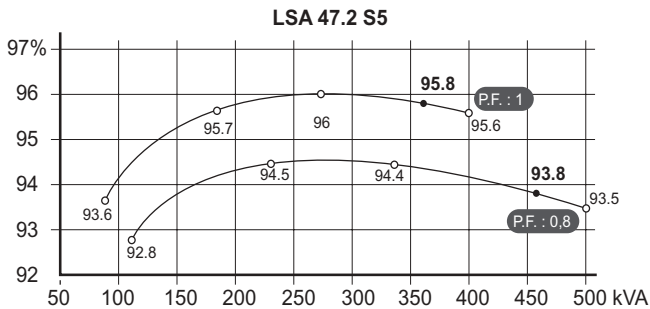
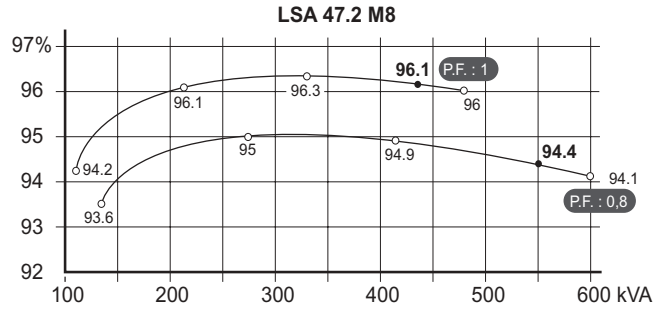
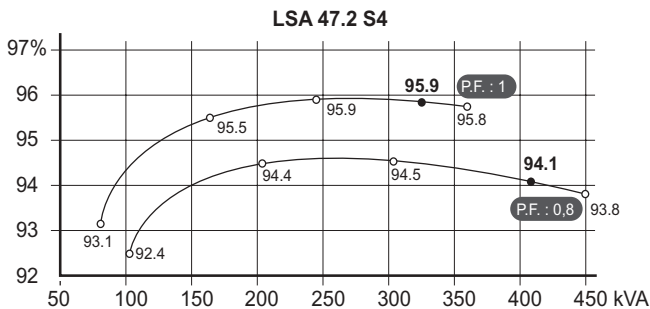
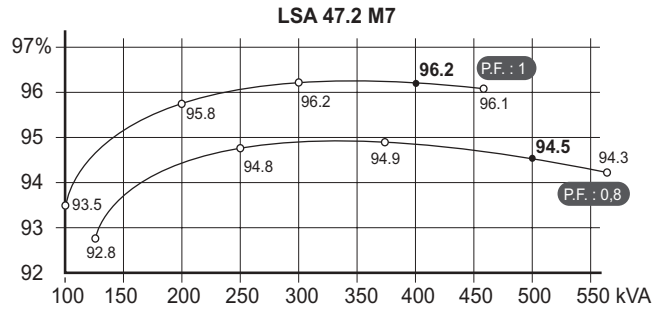
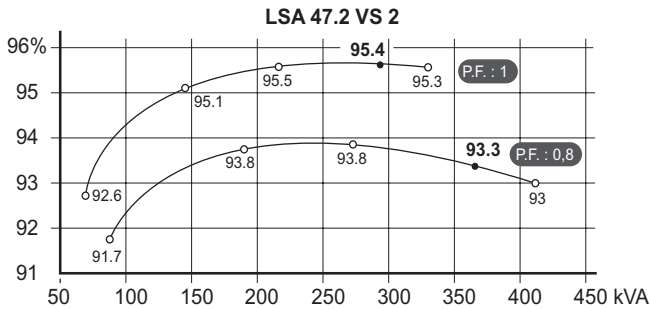

Reactances Class H / 400 V - Time constants (ms)

	VS2	S4	S5	M7	M8	L9	L9 (6f)
Kcc Short-circuit ratio	0,38	0,37	0,33	0,41	0,32	0,37	0,38
Xd Direct axis synchro.reactance unsaturated	336	322	357	307	360	330	325
Xq Quadra. axis synchr.reactance unsaturated	201	193	214	184	216	198	195
T'do Open circuit time constant	1738	1855	1855	1930	1958	1997	1997
X'd Direct axis transient reactance saturated	19,3	17,3	19,2	15,9	18,3	16,5	16,2
T'd Short-Circuit transient time constant	100	100	100	100	100	100	100
X''d Direct axis subtransient reactance saturated	13,5	12,1	13,5	11,1	12,9	11,4	11,6
T''d Subtransient time constant	10	10	10	10	10	10	10
X''q Quadra. axis subtransient reactance saturated	18,4	16,3	18	14,7	17	15	15,2
Xo Zero sequence reactance unsaturated	0,9	0,9	0,9	0,7	0,6	0,9	0,2
X2 Negative sequence reactance saturated	16	14,2	15,8	13	15	13,2	13,4
Ta Armature time constant	15	15	15	15	15	15	15

Other data - Class H / 400 V

io (A) No load excitation current	1	0,9	0,9	1	0,9	0,9	0,9
ic (A) Full load excitation current	3,8	3,5	3,8	3,6	3,7	3,7	3,7
uc (V) Full load excitation voltage	39	35	38	36	37	36	36
ms Recovery time ($\Delta U = 20\%$ trans.)	500	500	500	500	500	500	500
kVA Motor start. ($\Delta U = 20\%$ sust.) or ($\Delta U = 50\%$ trans.) SHUNT	722	928	928	1073	1159	1258	1258
kVA Motor start. ($\Delta U = 20\%$ sust.) or ($\Delta U = 50\%$ trans.) AREP	805	1035	1035	1195	1294	1400	1400
% Transient dip (rated step load) SHUNT / PF : 0,8 LAG	16,8	15,5	16,7	14,6	16,2	15	14,8
% Transient dip (rated step load) AREP / PF : 0,8 LAG	13,7	12,7	13,6	11,9	13,2	12,2	12,1
W No load losses	5440	5690	5690	6540	6120	6780	6880
W Heat rejection	20780	20470	23780	23040	26020	27490	26720

Transient voltage variation 400 V - 50 Hz

Load application (SHUNT excitation)

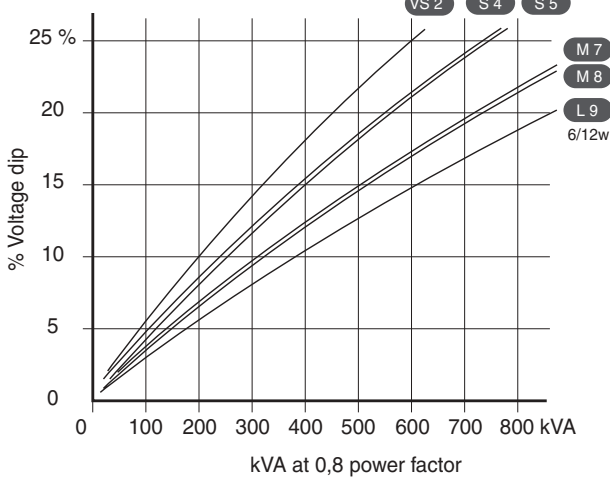

Load application (AREP or PMG excitation)

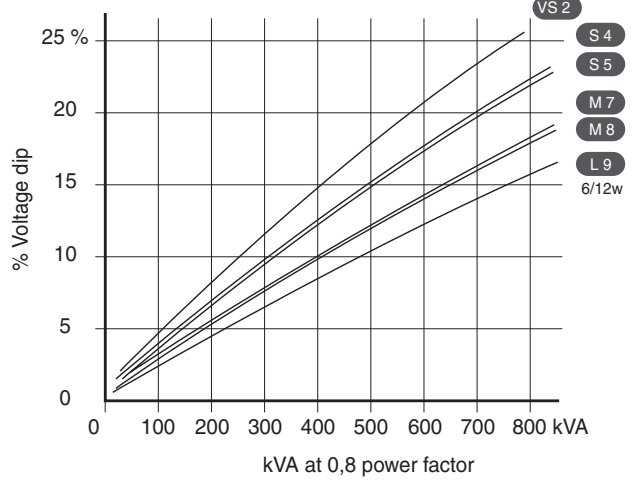

Load rejection (SHUNT excitation)

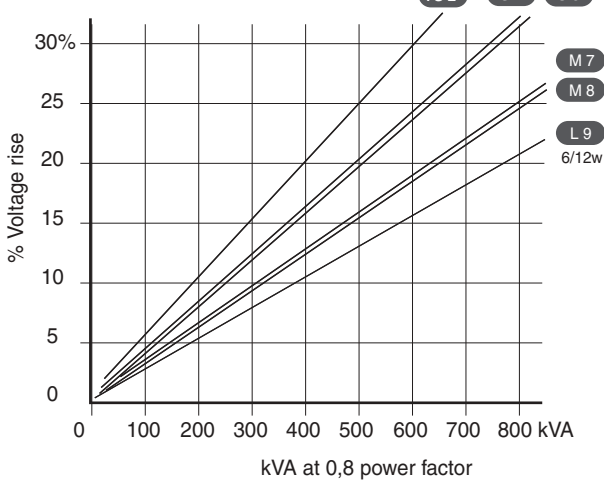

Load rejection (AREP or PMG excitation)

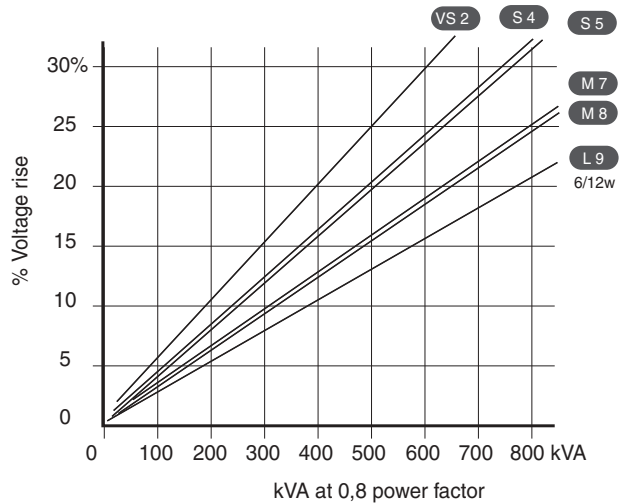

Motor starting (SHUNT excitation)

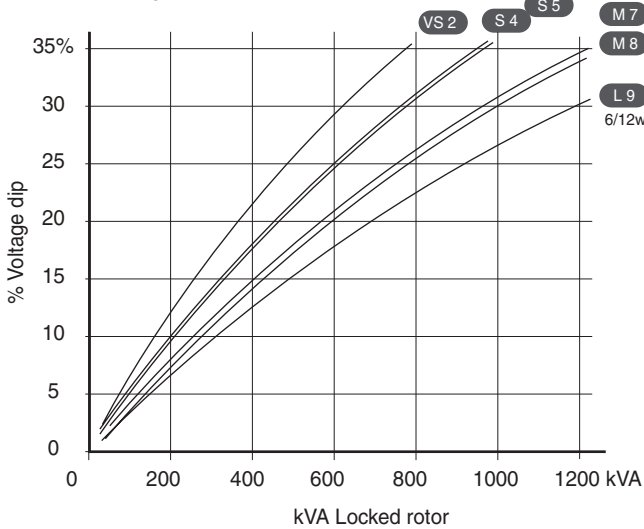

Motor starting (AREP or PMG excitation)

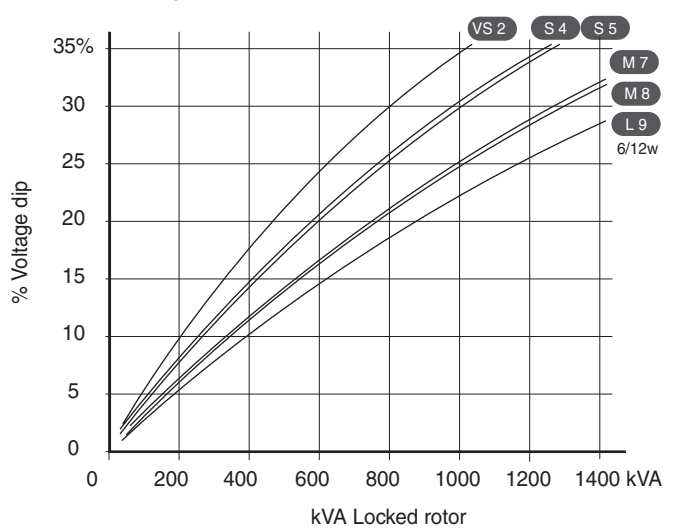

1) For a starting P.F. differing from 0,6, the starting kVA must be multiplied by $(\text{Sine } \varnothing / 0,8)$

2) For voltages other than 400V(Y) , 230V(I) at 50 Hz, then kVA must be multiplied by $(400/U)^2$ or $(230/U)^2$.

Efficiencies 60 Hz - P.F. :1 / P.F. : 0,8

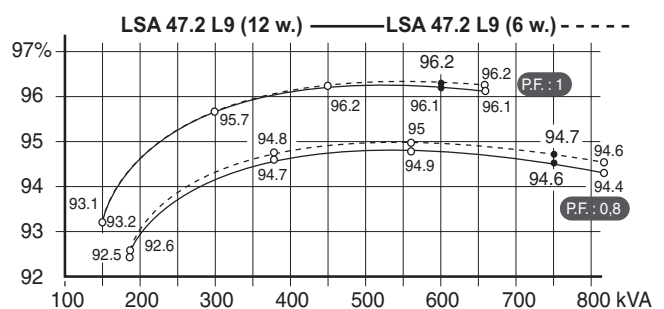
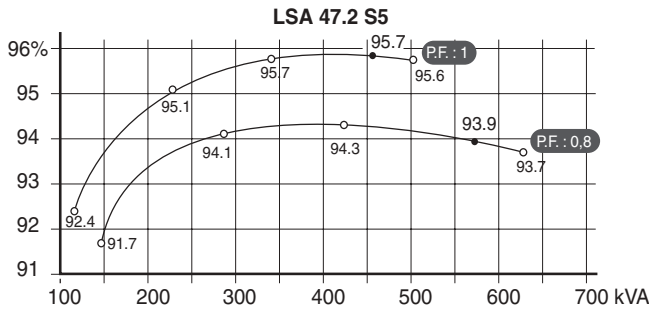
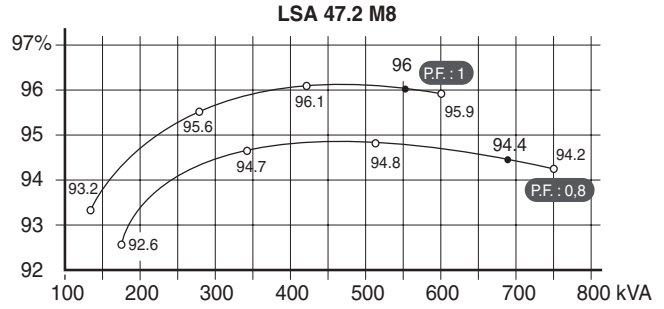
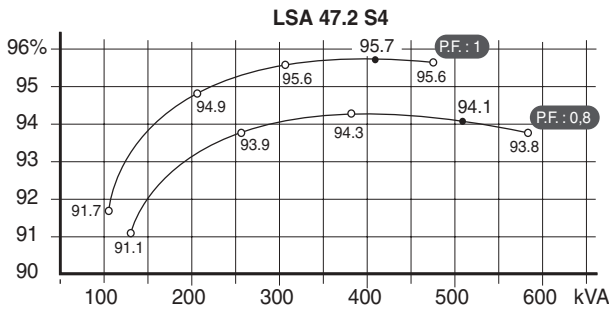
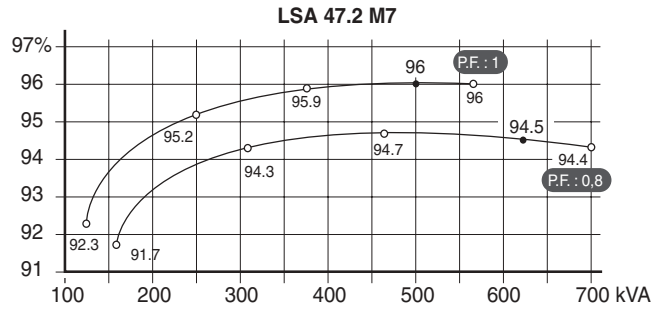
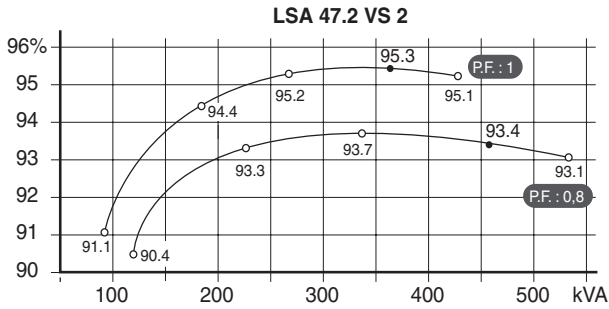

Reactances Class H / 480 V - Time constants (ms)

	VS2	S4	S5	M7	M8	L9	L9 (6f)
Kcc Short-circuit ratio	0,36	0,36	0,32	0,40	0,31	0,35	0,36
Xd Direct axis synchro.reactance unsaturated	349	335	373	319	376	344	338
Xq Quadra. axis synchr.reactance unsaturated	209	201	223	191	225	206	203
T'do Open circuit time constant	1738	1855	1855	1930	1958	1997	1997
X'd Direct axis transient reactance saturated	20,1	18	20,1	16,5	19,2	17,2	16,9
T'd Short circuit transient time constant	100	100	100	100	100	100	100
X"d Direct axis subtransient reactance saturated	14,1	12,6	14	11,6	13,4	11,8	12,1
T"d Subtransient time constant	10	10	10	10	10	10	10
X"q Quadra. axis subtransient reactance saturated	19,1	16,9	18,8	15,3	17,8	15,6	15,8
Xo Zero sequence reactance unsaturated	0,1	0,4	0,1	0,1	0,9	0,9	0,4
X2 Negative sequence reactance saturated	16,6	14,8	16,5	13,5	15,6	13,7	14
Ta Armature time constant	15	15	15	15	15	15	15

Other data - Class H / 480 V

io (A) No load excitation current	1	0,9	0,9	1	0,9	0,9	0,9
ic (A) Full load excitation current	3,9	3,5	3,9	3,7	3,8	3,7	3,7
uc (V) Full load excitation voltage	40	35	39	37	38	37	37
ms Recovery time ($\Delta U = 20\%$ trans.)	500	500	500	500	500	500	500
kVA Motor start. ($\Delta U = 20\%$ sust.) or ($\Delta U = 50\%$ trans.) SHUNT	890	1136	1136	1318	1433	1550	1554
kVA Motor start. ($\Delta U = 20\%$ sust.) or ($\Delta U = 50\%$ trans.) AREP	994	1271	1271	1473	1606	1733	1737
% Transient dip (rated step load) SHUNT / PF : 0,8 LAG	17,3	16	17,3	15	16,7	15,5	15,3
% Transient dip (rated step load) AREP / PF : 0,8 LAG	14,1	13	14,1	12,2	13,6	12,6	12,4
W No load losses	8540	8910	8910	10080	9530	10440	10580
W Heat rejection	25650	25650	29340	28630	32190	33870	33010

Transient voltage variation - 480 V - 60 Hz

Load application (SHUNT excitation)

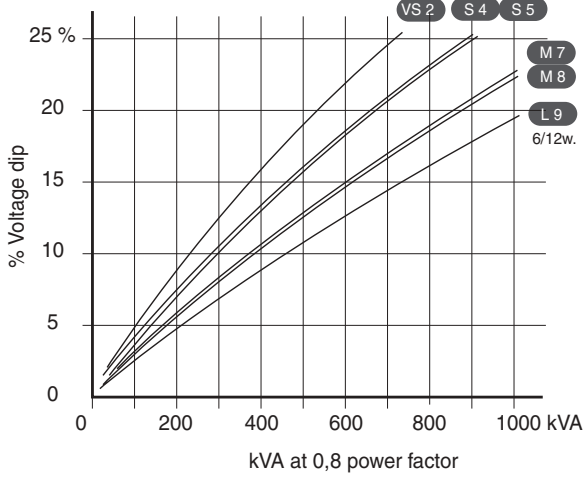

Load application (AREP or PMG excitation)

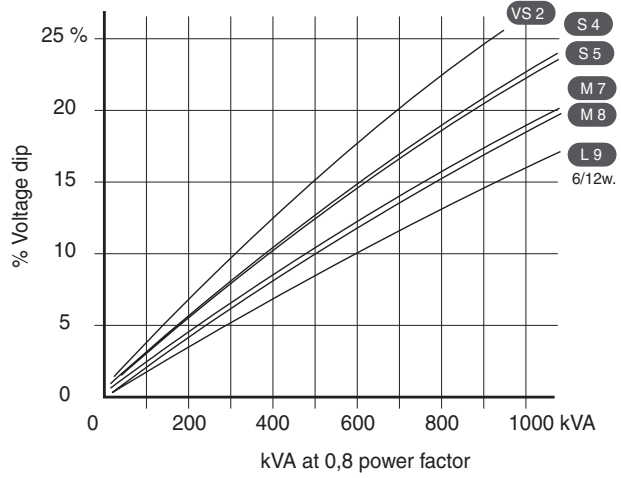

Load rejection (SHUNT excitation)

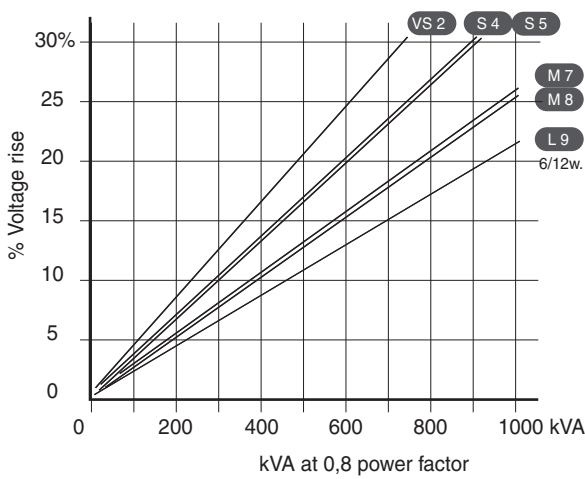

Load rejection (AREP or PMG excitation)

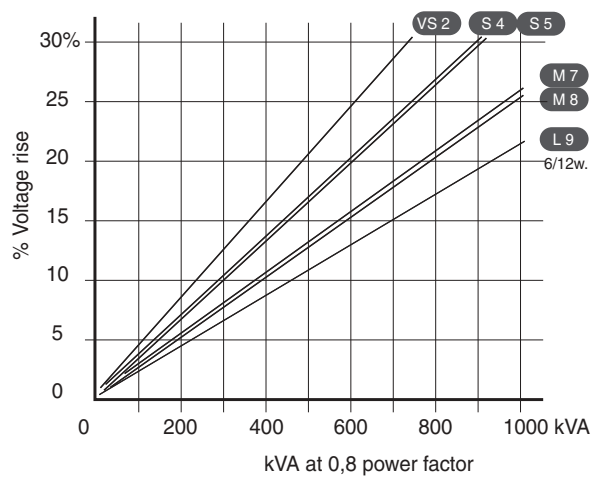

Motor starting (SHUNT excitation)

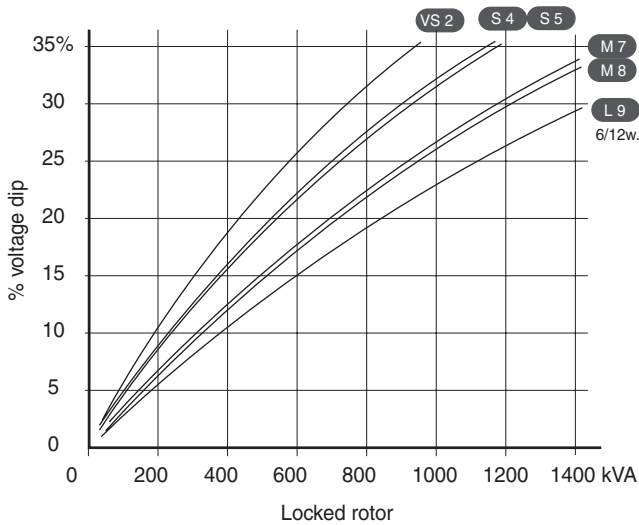

Motor starting (AREP or PMG excitation)

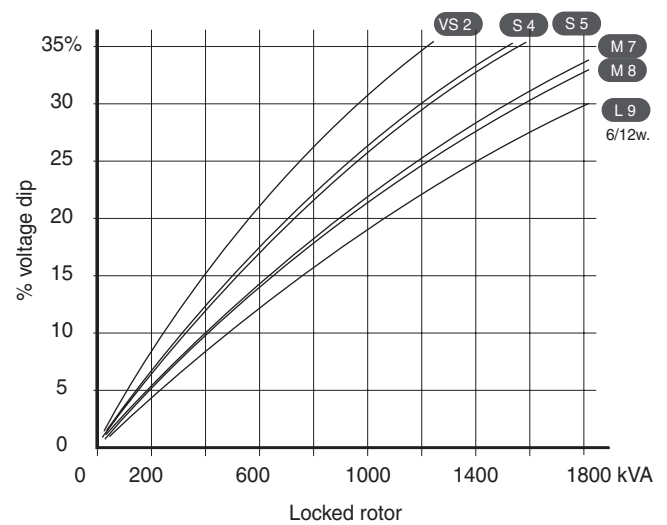

- 1) For a starting P.F. differing from 0,6, the starting kVA must be multiplied by $(\text{Sine } \varnothing / 0,8)$
- 2) For voltages other than 480V(Y), 277V(), 240V(YY) at 60 Hz, then kVA must be multiplied by $(480/U)^2$ or $(277/U)^2$ or $(240/U)^2$.

3 phase short-circuit curves at no load and rated speed (star connection Y)

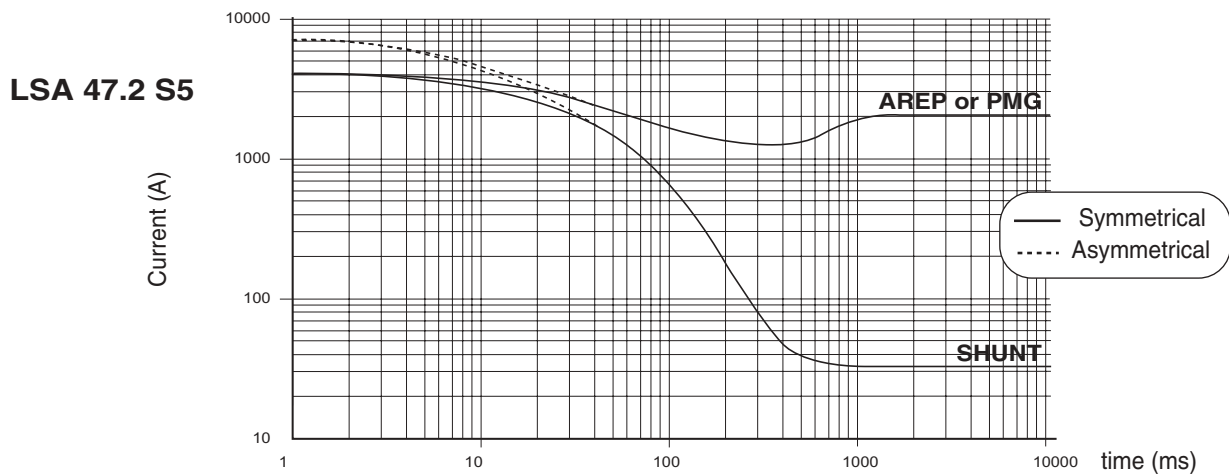
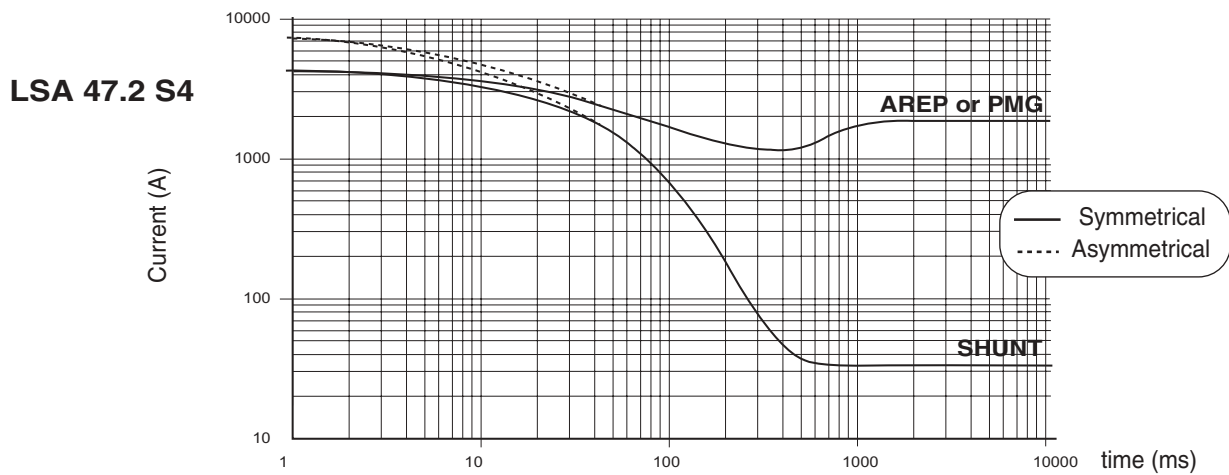
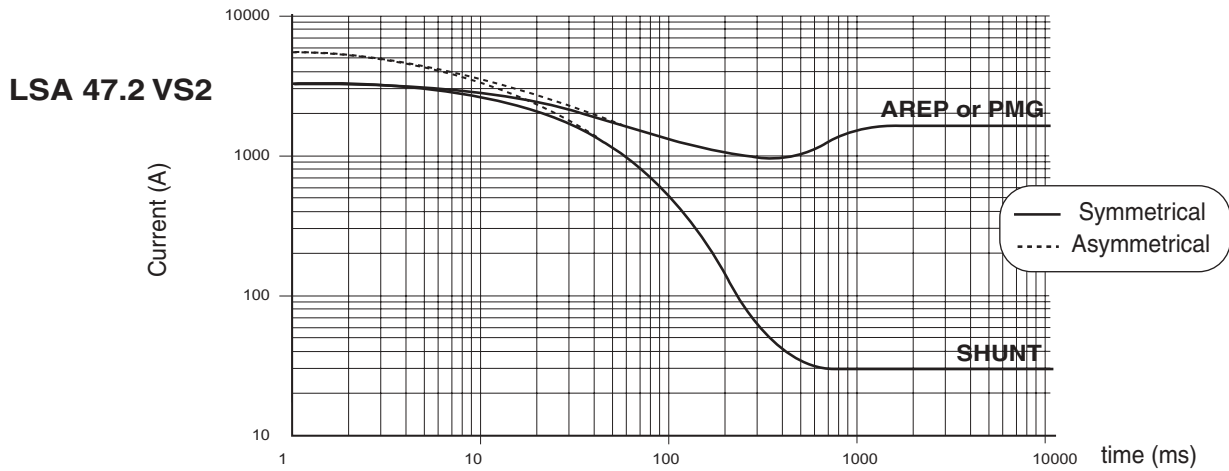

Influence due to connexion.

Curves shown are for star connection (Y).

For other connections, use the following multiplication factors :

- Series delta : Current value x 1,732
- Parallel star : Current value x 2

3 phase short-circuit curves at no load and rated speed (star connection Y)

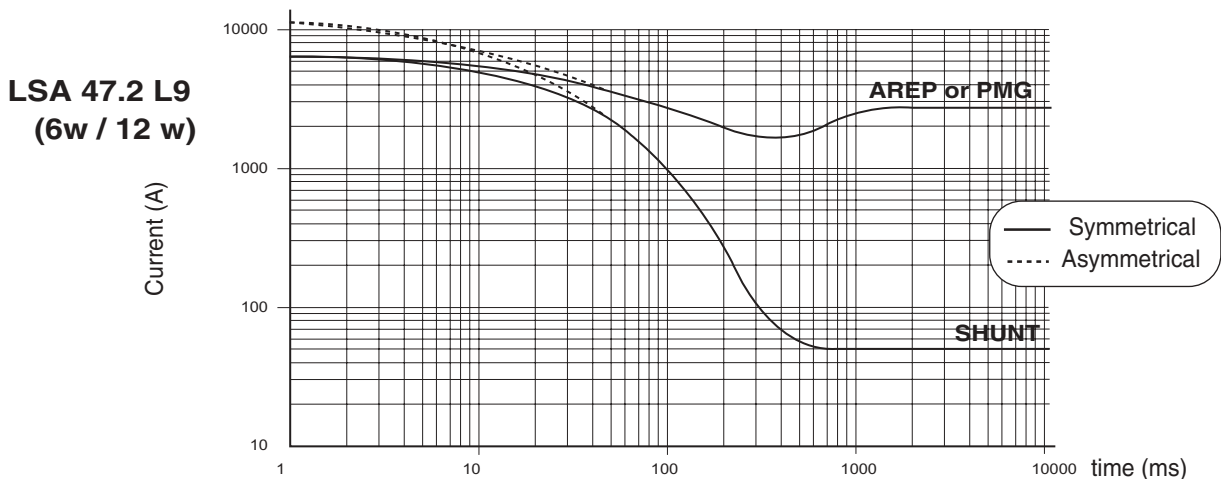
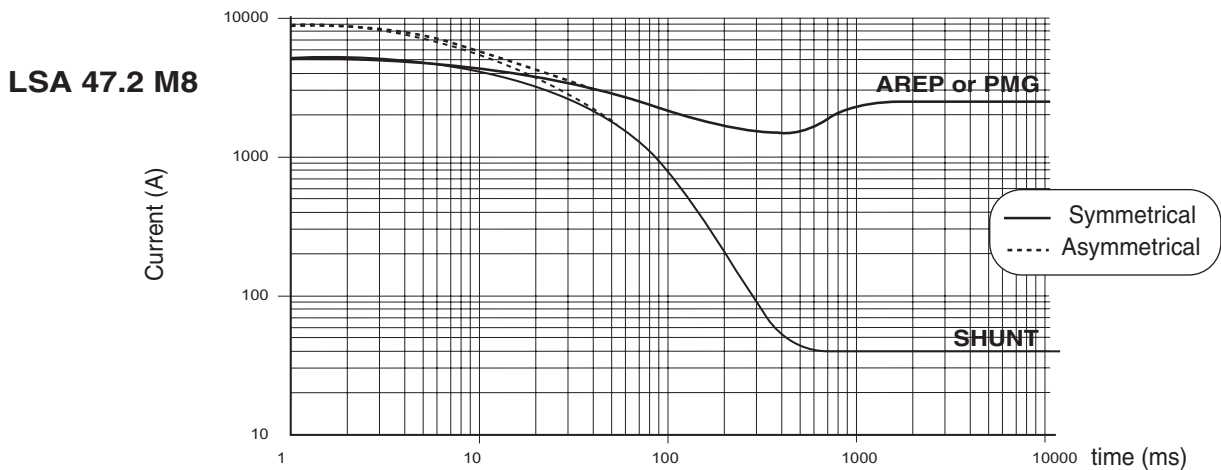
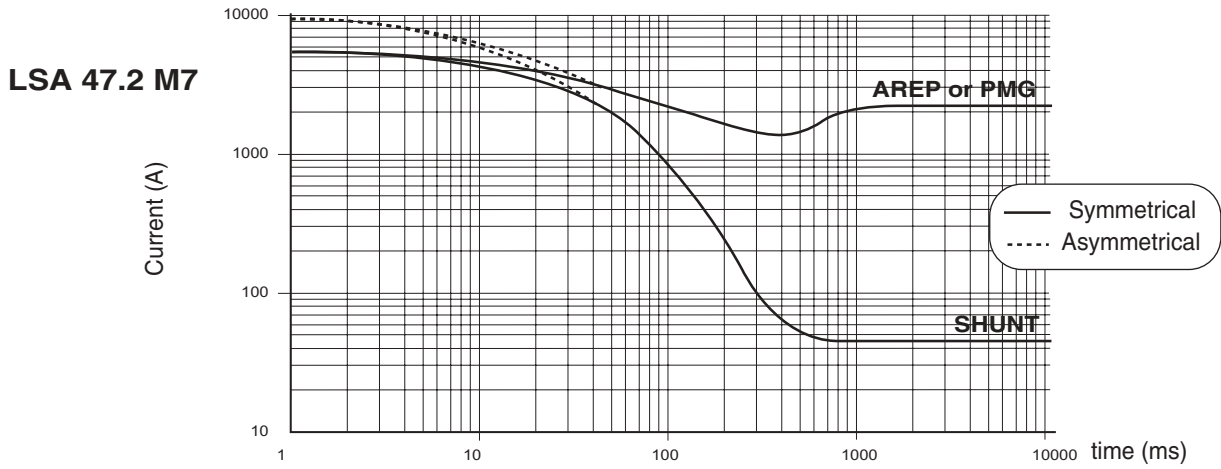

Influence due to short-circuit.

Curves are based on a three-phase short-circuit.

For other types of short-circuit, use the following multiplication factors :

	3 phase	2 phase L - L.	1 phase L - N.
Instantaneous (Max)	1	0,87	1,3
Sustained	1	1,5	2,2
Max sustained duration (AREP/ PMG)	10 sec.	5 sec.	2 sec.

Single bearing dimensions

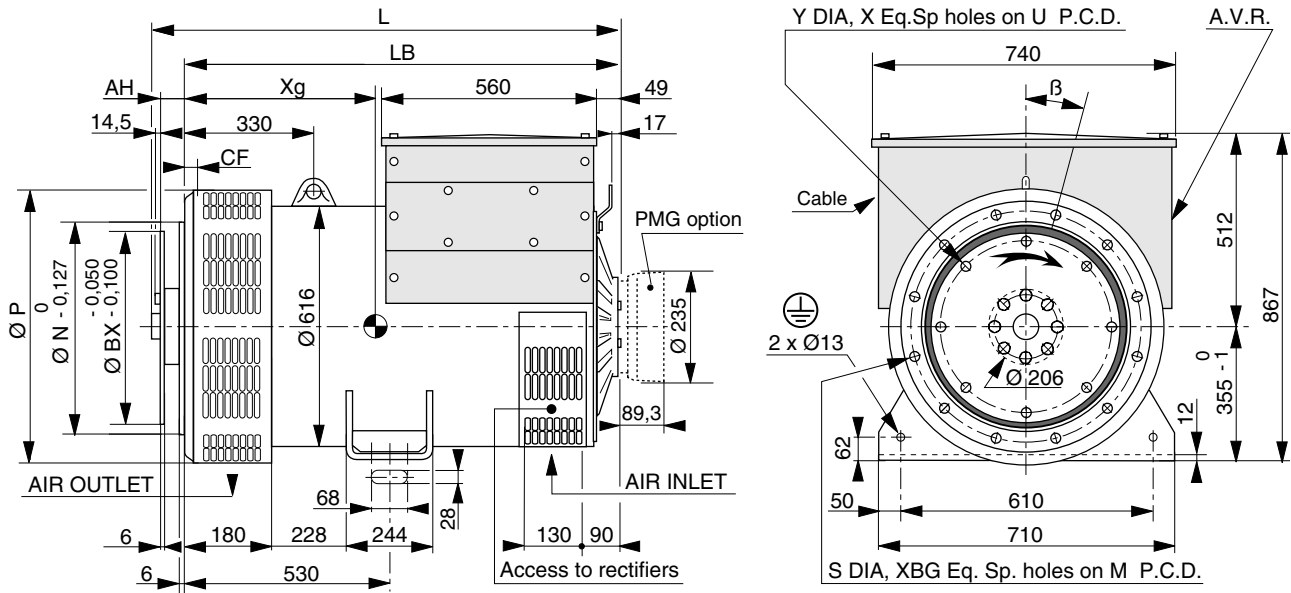

FRAME DIMENSIONS (mm)

TYPE	L max without PMG	LB	Xg	Weight(kg)
LSA 47.2 VS2	1041	996	437	976
LSA 47.2 S4	1101	1056	471	1113
LSA 47.2 S5	1101	1056	471	1113
LSA 47.2 M7	1201	1156	511	1240
LSA 47.2 M8	1201	1156	520	1289
LSA 47.2 L9	1221	1176	545	1372

COUPLING

Flex plate	11 1/2	14	18
Flange S.A.E 1	X	X	
Flange S.A.E 1/2		X	
Flange S.A.E 0		X	X

Flange dimensions (mm)

S.A.E.	P	N	M	XBG	S	β	CF
1	713	511,175	530,225	12	12	15	15
1/2	713	584,2	619,125	12	14	15	22
0	713	647,7	679,45	16	14	11	42

Flex plate dimensions (mm)

S.A.E.	BX	U	X	Y	AH
11 1/2	352,4	333,38	8	11	39,6
14	466,7	438,15	8	14	25,4
18	571,5	542,92	6	17	15,7

Torsional analysis data

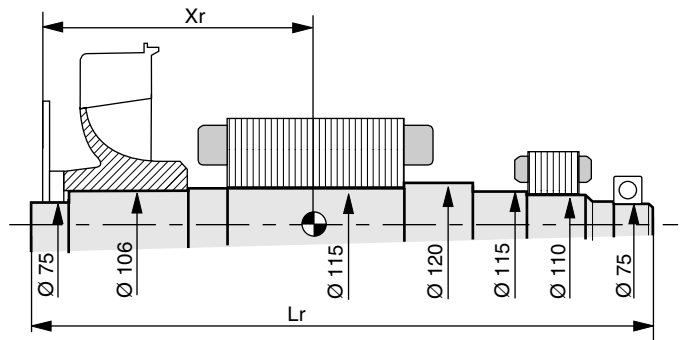

Gravity center : Xr (mm), Rotor length Lr (mm), Weight : M (kg), Moment of inertia : J (kgm²) : (4J = MD²)

TYPE	Flex plate S.A.E. 11 1/2				Flex plate S.A.E. 14				Flex plate S.A.E. 18			
	Xr	Lr	M	J	Xr	Lr	M	J	Xr	Lr	M	J
LSA 47.2 VS2	432,5	1029	387	5,99	418,3	1029	387	6,12	408,5	1029	387	6,38
LSA 47.2 S4	470	1089	442	6,90	456	1089	442	7,03	446	1089	442	7,29
LSA 47.2 S5	470	1089	442	6,90	456	1089	442	7,03	446	1089	442	7,29
LSA 47.2 M7	510	1189	495	7,61	496	1189	495	7,74	486	1189	495	8
LSA 47.2 M8	521	1189	514	8,01	507	1189	514	8,14	497	1189	514	8,40
LSA 47.2 L9	542	1209	547	8,52	528	1209	547	8,65	518	1209	547	8,91

Two bearing dimensions

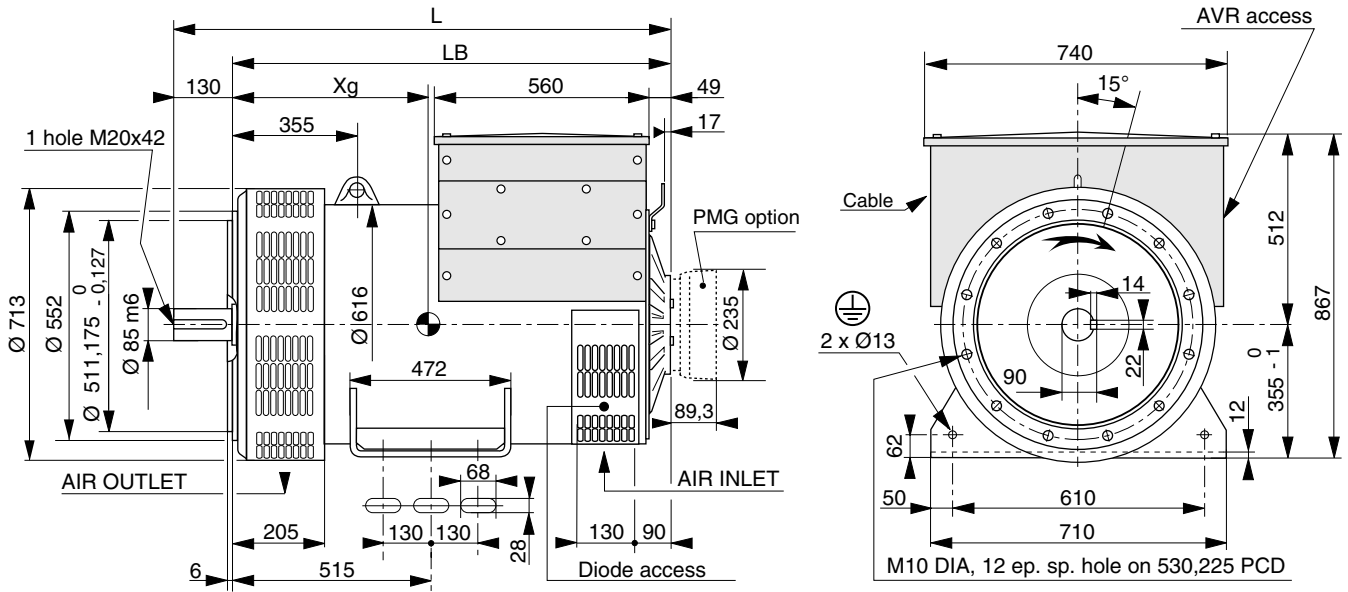

FRAME DIMENSIONS (mm)

TYPE	L maxi without PMG	LB	Xg	Weight (kg)
LSA 47.2 VS2	1151	1021	457	996
LSA 47.2 S4	1211	1081	491	1126
LSA 47.2 S5	1211	1081	491	1126
LSA 47.2 M7	1311	1181	531	1253
LSA 47.2 M8	1311	1181	531	1302
LSA 47.2 L9	1331	1201	565	1392

Torsional analysis data

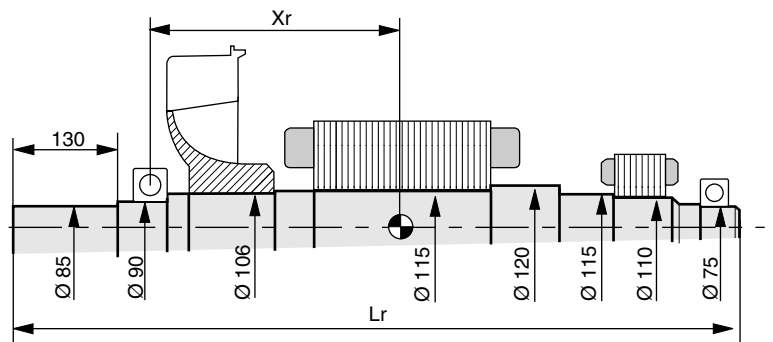

Gravity center : Xr (mm), Rotor length Lr (mm), Weight : M (kg), Moment of inertia : J (kgm²) : (4J = MD²)

TYPE	Xr	Lr	M	J (kg)
LSA 47.2 VS2	396,4	1139	368,5	5,79
LSA 47.2 S4	433,2	1199	424	6,70
LSA 47.2 S5	433,2	1199	424	6,70
LSA 47.2 M7	473	1299	476,2	7,41
LSA 47.2 M8	483,5	1299	494,9	7,81
LSA 47.2 L9	504,5	1319	528	8,32



LEROY-SOMER 16015 ANGOULÊME CEDEX - FRANCE

RCS ANGOULÊME N° B 671 820 223
S.A. au capital de 62 779 000 €

www.leroy-somer.com